



Andrews McMeel

QUIRK



BOOKS

An Imprint of Andrews McMeel Publishing

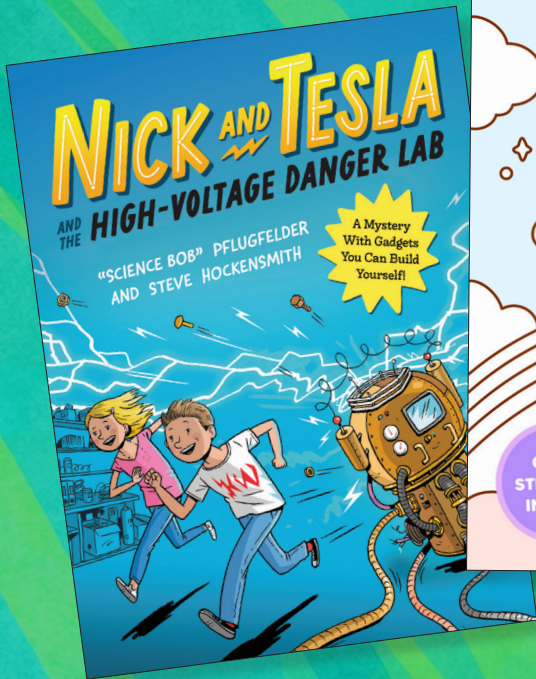
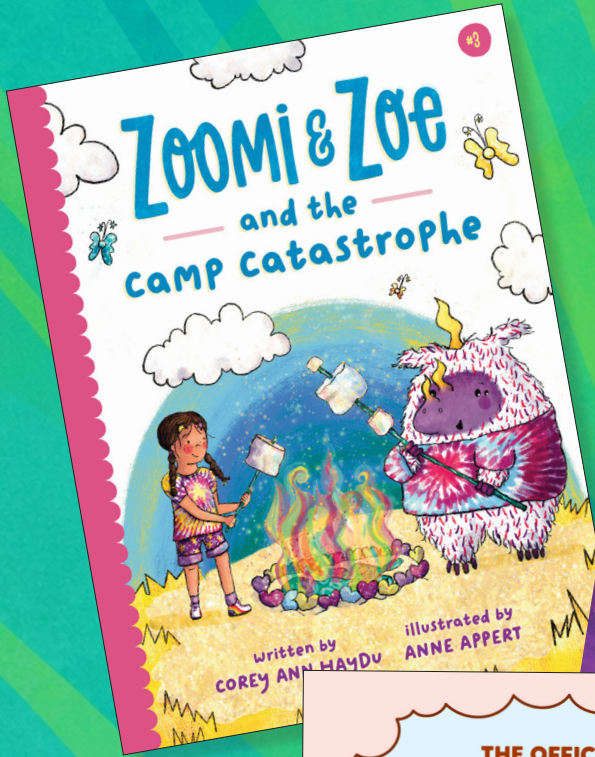



Andrews McMeel



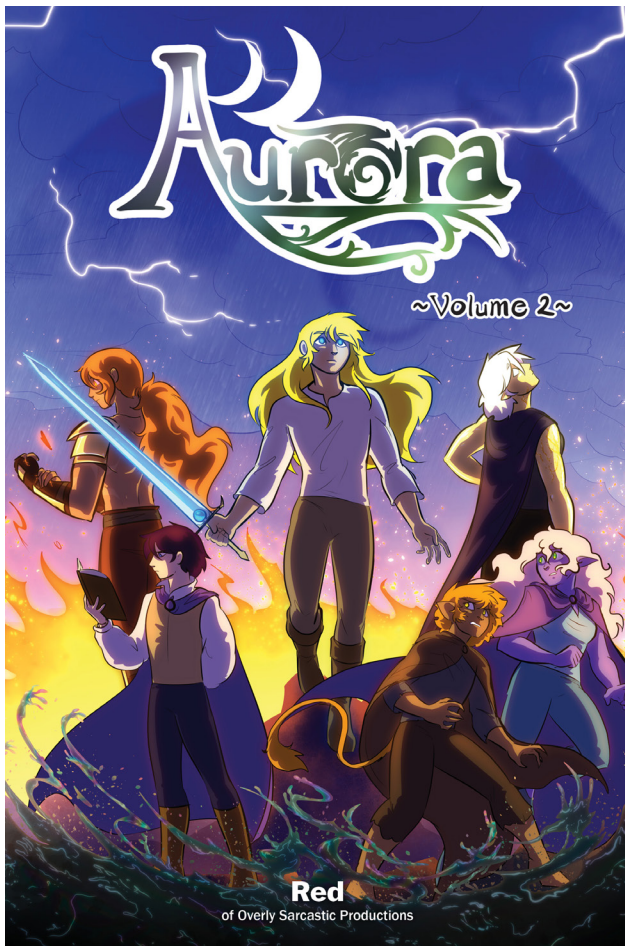

Aurora Volume 2

By Red

Red's YouTube channel *Overly Sarcastic Productions* has **2.42 million subscribers and over 777 million views!**

Following the exciting events of *Aurora: Volume 1*, Kendal and his heroic companions continue on their quest. Looking to rescue Vash and uncover more secrets about the Void Dragon, Kendal, Erin, Alinua, and Falst travel to new cities and meet new friends and foes alike. Will they save their kidnapped god, defeat the Void Dragon, and learn more about the Collector's plans to stop her in time? Find out in *Aurora: Volume 2!*

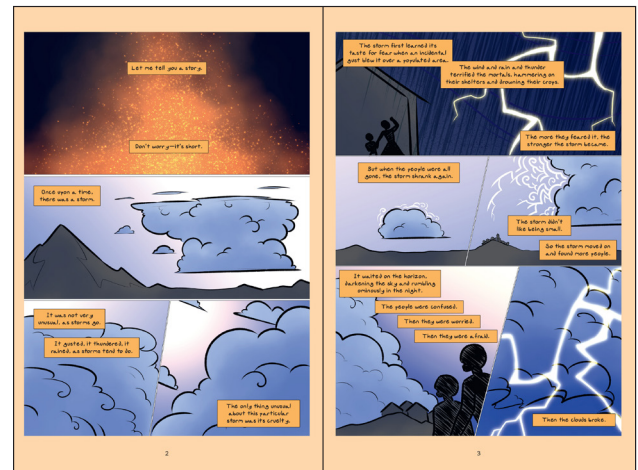

Also Available:



ISBN: 978-1-52489-640-3
 Translation rights sold: Spanish
 (Grupo Anaya)



Subject:
 Young Adult Fiction – Comics & Graphic
 Novels – Fantasy
 Young Adult Fiction – Comics & Graphic
 Novels – Coming of Age
 Young Adult Fiction – Comics & Graphic
 Novels – Humorous

ISBN: 978-1-52489-641-6
 Price: \$22.99 USD
 Paperback, 432 pages, 152 x 229 mm
 Age Range: 14-17

Translation Rights Sold: Spanish (Grupo Anaya)

Publication Date: April 2026
 Final PDF Available: Now

Folk Remedy Book 1

By Jem Yoshioka

Inuyasha meets Studio Ghibli’s *Princess Mononoke* and *Spirited Away* in a magical middle grade graphic novel.

Praise for Book 1: From Kirkus Reviews, “This action-packed series opener features plenty of magical thrills. The charming illustrations have a historical feeling that evokes traditional Japanese woodblock prints, effectively using different color palettes to distinguish the human and spirit worlds. An intriguing, page-turning adventure infused with Japanese folklore.”

Hits an important age gap for readers ages 13-17.

At twelve years old, Maple Akimura’s future has already been decided. With her mother insisting she become an apprentice at the family apothecary business, Maple sees a small life in her village ahead of her.

Maple would rather spend her time with Kunio, her new friend visiting from Taisho City, than study her family’s history. Her mother insists she reads the family book detailing the Akimuras’ relationship to yokai (spirits and supernatural beings) over generations. To Maple, the stories of the yokai are just a remnant of traditional village living, amid 1920s Japan’s rapidly advancing technology and the glamor of modern urban life—especially in bustling Taisho City. But Maple’s encounter with a mischievous yokai named Ember sweeps the pair into the hidden spirit world, with only Maple’s family stories to guide them.

Now, they must navigate hidden dangers, strange creatures, and dark secrets to send Ember home and empower Maple to find her own path.

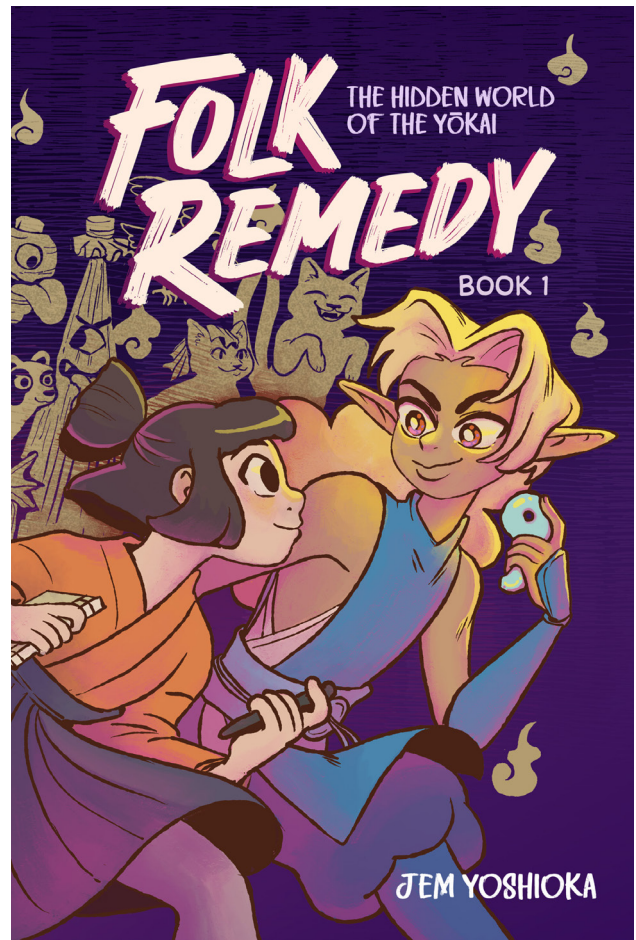

Subject:
 Young Adult Fiction – Comics & Graphic Novels – Fairy Tales, Folklore, Legends, & Mythology
 Young Adult Fiction – Comics & Graphic Novels – Fantasy
 Young Adult Fiction – Comics & Graphic Novels – Action & Adventure
 Young Adult Fiction – Comics & Graphic Novels – Historical
 Young Adult Fiction – Comics & Graphic Novels – Manga

ISBN: 979-8-88160-2-642
Price: \$14.99 USD
 Paperback, 240 pages, 152 x 229 mm
Age Range: 13-17

Translation Rights Sold: All rights available

Publication Date: September 2025
Final PDF Available: Now

Unfamiliar

By Haley Newsome

Unfamiliar is an ongoing webcomic series with over **24.5 million views!**

Haley Newsome (aka LavenderTowne) has **2.3 million subscribers** on her Youtube channel where she shares drawing videos and **312,000 Instagram followers** (as of January 2026).

Children’s Book Council Young Adult Favorites Awards 2024.

Young Adult Favorites Awards, 9th-12th Grade Reading List Selection by the Children’s Book Council

“Newsome takes advantage of the graphic format to land countless visual jokes and imbue the world with personality and whimsy. Wide-eyed characters spellbind in this cute and cozy tale.” – Kirkus Reviews

Young kitchen witch Planchette gets an incredible deal on a new house in a magical town. Turns out, there’s a reason: it’s haunted! After unsuccessfully attempting to get these unwanted ghosts to leave, she realizes the only thing to do is to help them with their problems. Along the way, she befriends a shy siren who hates being popular, a girl battling a curse, and a magically-challenged witch from a powerful coven.



Also Available:



Join Planchette and her friends as they work together to handle a blackmailing Faerie King, a possible new romance, and an overnight camping trip in an evil forest!

ISBN: 978-1-52488-236-5
144 pages, 140 x 203 mm
Final PDF Available: Now

Subject:
 Young Adult Fiction – Comix & Graphic Novels – Paranormal
 Young Adult Fiction – Fantasy – Wizards & Witches
 Young Adult Fiction – Comics & Graphic Novels – Humorous

ISBN: 978-1-52487-683-6
Price: \$15.99 USD
 Paperback, 160 pages, 140 x 203 mm
Age Range: 13–17

Translation Rights Sold: French (Bliss Editions), Spanish/Catalan (Edebé Editions)

Publication Date: December 2022
Final PDF Available: Now



Latina Superheroes: Bandita & A La Brava

By K.B. Spangler, Ale Presser

Bandita is a modern-day cowgirl living in New York City, known for her fierce sense of justice and southern charm. When she learns a Broadway gang is exploiting performers, Bandita goes undercover to bring the perpetrators to light.

Meanwhile, a new agent named Muñeca assembles the full A La Brava team. With the introduction of the Fair Shares Bill—a proposed tax on billionaires—female politicians begin mysteriously dying. It’s up to Bandita and her fellow Latina Superheroes to uncover who’s behind the murders and stop them before it’s too late.

In this thrilling conclusion to *Latina Superheroes*, creator Kayden Phoenix brings together five powerful young women who fight for justice, equality, and the heart of their communities. Perfect for fans of Marvel’s Echo, this young adult graphic novel celebrates Latina resilience, unity, and heroism.

Also Available:



ISBN: 978-1-52489-258-6



ISBN: 978-1-52489-258-6

Subject:
Young Adult Fiction – Hispanic & Latino
Young Adult Fiction – Superheroes
Young Adult Fiction – Action & Adventure

ISBN: 978-1-52489-262-3
Price: \$18.99 USD
Paperback, 176 pages, 165 x 203 mm
Age Range: 14–18

Translation Rights Sold: All rights available

Publication Date: August 2026
Final PDF Available: March 2026

When the Rain Came

By Matt Eicheldinger

New York Times bestselling author with 390K followers on Instagram and over 70 million views on TikTok!

“Like *Dry* by Neal and Jordan Shusterman and *Tilt* by Emma Pattee, *When the Rain Came* is taut and terrifying. Fans of dystopian fiction won’t be able to put it down.” – Megan E. Freeman, *New York Times* bestselling author of *AWAY* and *ALONE*

“This fast-paced novel with dystopian elements will keep readers invested in its action-packed plot. A reoccurring mystery that’s hinted at throughout the narrative leaves ample room for the sequel that’s sure to be in high demand. ... A well-plotted survival series opener.” – Kirkus Reviews

“If we stay here, if we keep wandering without a real plan, we won’t last. Maybe The Hill is dangerous. But maybe it’s not. It’s the only plan we have.”

Seventeen-year-old Aurora knows how to survive. Life in the foster system has taught her how to stay quiet, stay smart, and stay ready. But nothing could prepare her for this: a never-ending storm that swallows cities, drowns forests, and turns the world into a flooded wasteland.

Trapped in a collapsing house with her strict prepper foster parents, Aurora is forced to live by their rules just to stay alive. Until the day they disappear without a trace.

Alone. Abandoned. And running out of time.

All Aurora has is a waterlogged scrap of paper and a name: “The Hill.”

With looters closing in and the floodwaters rising higher each day, she’s left with **one impossible choice**—stay and wait for the storm to take her, or risk everything on a journey through the drowned remains of the world, to a find a place that may or not exist.

It’s forward or nothing.



Subject:
Young Adult Fiction – Dystopian
Young Adult Fiction – Action & Adventure – Survivor Stories
Young Adult Fiction – Science Fiction – Apocalyptic & Post-Apocalyptic

ISBN: 979-8-88160-513-1
Price: \$14.99 USD
Paperback, 320 pages, 140 x 203 mm
Age Range: 13–15

Translation Rights Sold: All Rights Available

Publication Date: March 2026
Final PDF Available: Now

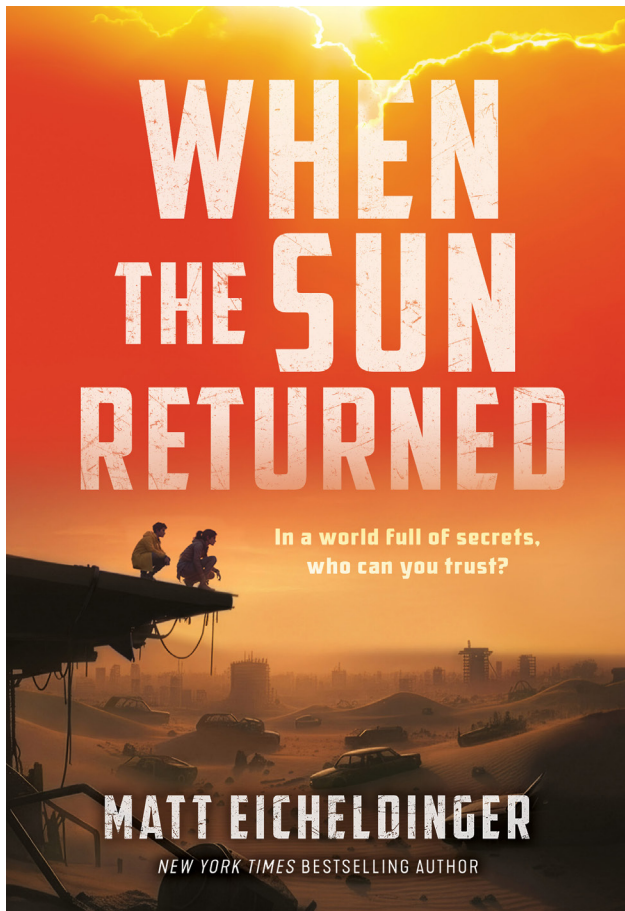

When the Sun Returned

By Matt Eicheldinger

Aurora and Kota journey toward Redfern—a refugee shelter that promises safety but demands obedience. Inside, nothing is simple. Trust is currency. Secrets are weapons. And *The Hill* is still out there. . . .

As the heat presses in, Aurora can feel Kota slipping further away from her reach, even though their survival depends on each other. But the secret he’s hiding could destroy more than just the fragile trust between them, it could doom them all.

Survival isn’t guaranteed. One mistake and everything burns.

From *New York Times* and *USA Today* bestselling author Matt Eicheldinger comes a blistering sequel to *When the Rain Came*, his critically renowned book for teens and young adults.

A must-read for fans of *Dune*, *Life As We Knew It*, and Neal Schusterman, *When the Sun Returned* is a haunting, heart-racing tale of survival under a burning sky and the bonds that turn strangers into families

Subject:

Young Adult Fiction – Dystopian
 Young Adult Fiction – Action & Adventure – Survivor Stories
 Young Adult Fiction – Science Fiction – Apocalyptic & Post-Apocalyptic

ISBN: 979-8-88160-515-5

Price: \$14.99 USD

Paperback, 320 pages, 140 x 203 mm

Age Range: 13–15

Translation Rights Sold: All Rights Available

Publication Date: November 2026
Final PDF Available: June 2026

Across Enchanted Lands (Phoebe and Her Unicorn Series)

By Dana Simpson

This bestselling series has sold over 3 million copies worldwide since 2014 and was revised in 2024 with a bold, visually impactful design to draw in a new generation of believers in the power of storytelling, friendship, and unicorns.

Phoebe and Her Unicorn books have appeared on the New York Times Best Seller List and have been kid favorites for more than 10 years.

24 titles in the series!

Step into a world where sass meets sparkle in *Phoebe and Her Unicorn*, the delightfully witty comic strip by Dana Simpson. Follow the adventures of Phoebe, a clever and quirky 10-year-old, and her best friend Marigold Heavenly Nostrils—a dazzling unicorn with a flair for drama and a magnificent mane. Together, they navigate the ups and downs of school, friendship, and misfiring magic spells. Packed with clever dialogue, whimsical illustrations, and just the right amount of snark, this comic is a joyful celebration of imagination, individuality, and the kind of friendship that’s truly legendary. This dynamic duo proves that growing up is way more fun with a unicorn by your side

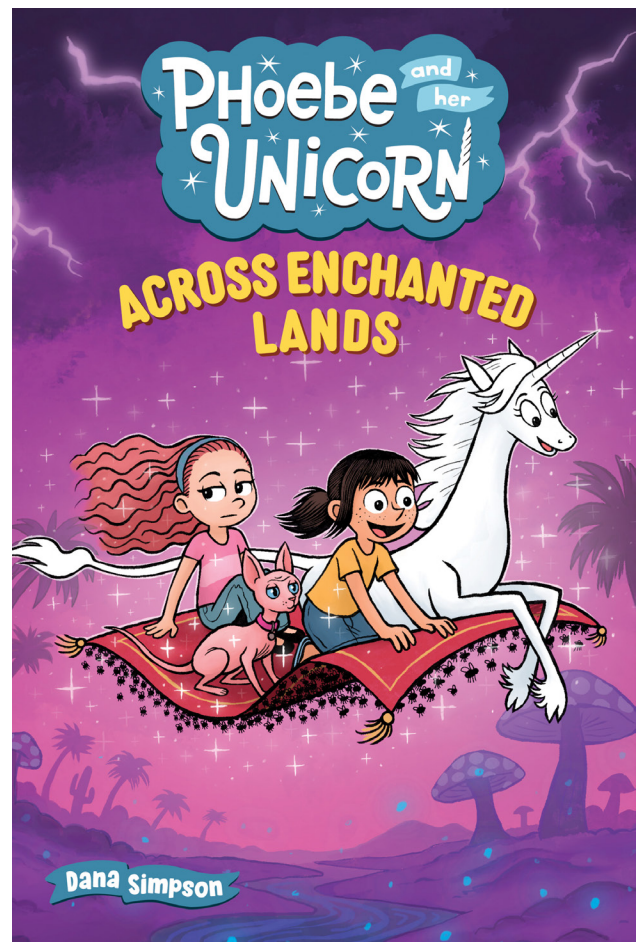

Also Available:



ISBN: 978-1-5248-8784-1
Publication date:
February 2025



ISBN: 979-8-88160-244-4
Publication date:
October 2025



ISBN: 979-8-88160-245-1
Publication date:
February 2026



ISBN: 979-8-88160-592-6
Publication date:
May 2026

Subject:
Juvenile Fiction – Comics & Graphic Novels
– Fairy Tales, Legends & Mythology
Juvenile Fiction – Fantasy – Dragons,
Unicorns & Mythical Creatures
Juvenile Fiction – Social Themes –
Friendship

ISBN: 979-8-88160-246-8
Price: \$12.99 USD
Paperback, 176 pages, 152 x 229 mm
Age Range: 8-12

Translation Rights Sold (to various titles in the series): Czech (reverted), Dutch (DeFontein), French (404 Editions), German (reverted), Hebrew (reverted), Hungarian (Kiadó), Italian (Tunue), Polish (Egmont Poland), Portugal (Penguin Random House), Romanian (Editura Art), Spanish (Penguin Random House), Ukrainian (Ranok)

Publication Date: October 2026
Final PDF Available: May 2026

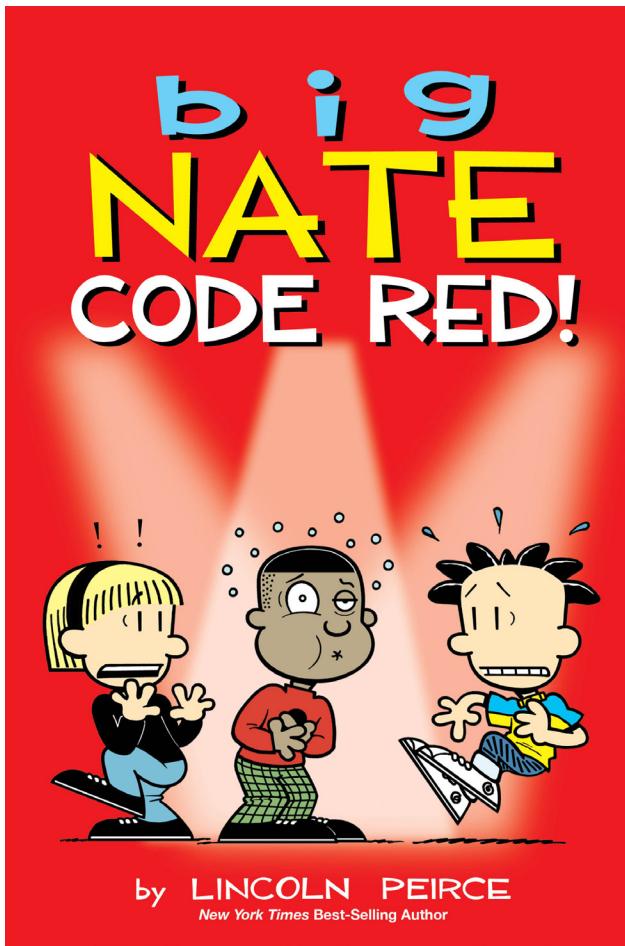

Big Nate and the Curse of the Puffy Shorts

By Lincoln Peirce

With more than 12 million *Big Nate* books sold since 2010, Big Nate is one of the most popular middle grade characters in circulation.

New York Times bestselling series!

In this new collection of full-color Big Nate comics, Lincoln Peirce's beloved sixth-grade mischief-maker is on a roll, causing classroom chaos, dodging detention, and leading his soccer team to new heights and lows. From battling his nemesis Gina and dodging the wrath of his teacher Mrs. Godfrey to dreaming up epic pranks, Nate's antics are guaranteed to crack you up and are perfect for kids ages 8-11, including reluctant readers. Thanks to Nate and friends like Francis, Dee Dee, Teddy, and Chad, the halls of P.S. 38 are filled with intrigue, drama, and silliness. So grab your Cheez Doodles and dive into the hilarious world of *Big Nate*!

Also Available:

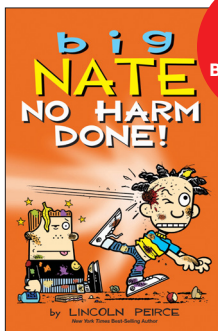

ISBN: 979-8-88160-241-3
Publication Date: September 2025

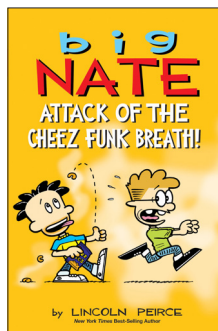

ISBN: 978-1-52488-783-4
Publication Date: March 2025

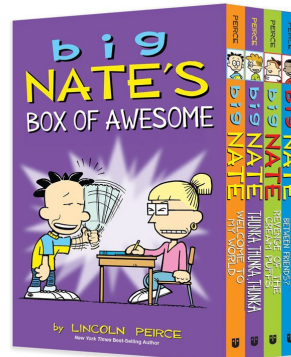

ISBN: 979-8-88160-591-9
Publication Date: October 2025

Subject:
 Juvenile Fiction – Comics & Graphic Novels – Humorous
 Juvenile Fiction – Comics & Graphic Novels – Action & Adventure
 Juvenile Fiction – Social Themes – Friendship

ISBN: 979-8-88160-243-7
Price: \$24.99 USD
 Paperback, 176 pages, 152 x 229 mm
Age Range: 8-12

Translation Rights Sold (to various titles in the series): Dutch (DeFontein), French (reverted), Hebrew (Keter), Italian (Brioschi), Portugal/Portuguese (Penguin Random House), Romanian (Editorial Art), Turkish (Epsilon)

Publication Date: September 2026
Final PDF Available: April 2026

Cat Ninja: The Dog Days

By Marcie Colleen, Stephanie Cooke, Matthew Cody

Over 200,000 copies sold of the series!

When Adonis's super-strength zoomies create a huge mess (and leave a dog-shaped hole in the wall), he hears the two worst words he knows: Bad dog! Worried that his villainous origins mean he can never be truly good, Adonis turns to his creator, Doctor Von Malice, for help. But what she offers is a double-cross disguised as a fresh start — a complete reboot that would erase his personality and wipe away all memories of the friends and family who love him.

Now, Cat Ninja, Fleabot, and a factory-reset Adonis must face mutant guinea pigs, a villainous vet, and an old foe with an explosive history to recover the literal keys to restoring Adonis to his lovable, slobbery self.

Adored by kids, teachers, and librarians alike, these hilarious, heartfelt full-color stories teach kids about friendship, bravery, and how to choose what kind of dog—or person—you want to be!

Includes a bonus tale featuring Master Hamster!



Also Available:



ISBN: 978-1-5248-6094-3



ISBN: 978-1-5248-6758-4



ISBN: 979-8-88160-245-1



ISBN: 978-1-5248-7585-5



ISBN: 978-1-5248-8228-0



ISBN: 978-1-5248-8878-7

Subject:

Juvenile Fiction – Comics & Graphic Novels
– Fairy Tales, Legends & Mythology
Juvenile Fiction – Fantasy – Dragons,
Unicorns & Mythical Creatures
Juvenile Fiction – Social Themes –
Friendship

ISBN: 979-8-88161-160-6

Price: \$12.99 USD

Paperback, 160 pages, 152 x 229 mm

Age Range: 8–172

Translation Rights Sold to the Series):

Catalan (Fundación Santa María), Czech
(Euromedia), Spanish (Fundación Santa
María)

Publication Date: September 2026

Final PDF Available: May 2026

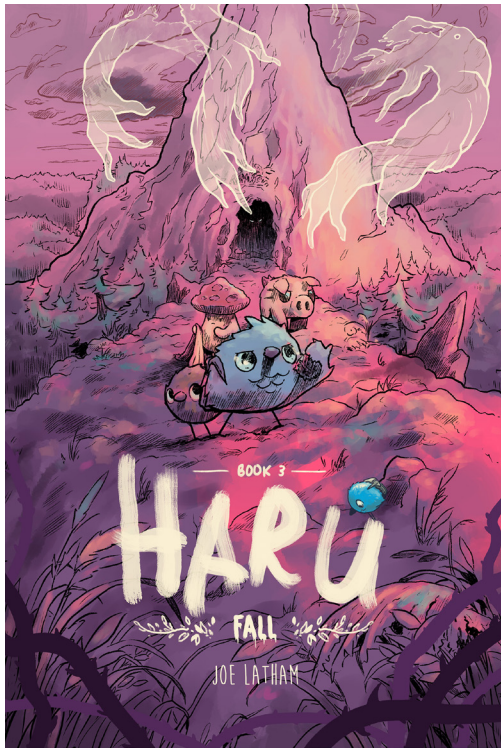

Publication Date: October 2025
ISBN: 978-1-5248-9766-6

Haru: Fall

By Joe Latham

“Latham sets this dazzling work in a Tolkienesque world, employing clever pen and ink drawings awash in luminous colors to deliver a cliffhanger ending that will have readers eagerly anticipating the next book in the series.” – Publishers Weekly

Broken Frontier Best Colorist Winner

Leeds Book Awards Middle Grade Graphics Winner

In *The Valley*, best friends Haru and Yama both dream of leaving as they're bullied at school, frustrated at home, and struggling to figure out who they are. One day, a powerful artifact connects itself to Yama, and they discover that they'll have to journey to The Beacon in search of answers.

Created by artist Joe Latham, this beautifully illustrated graphic novel series is a coming-of-age tale that spans the changing of seasons, beginning in spring and in Book 3 ending in spring for a complete cycle. A story of heart, growing up, and the sacrifices we make for those we love, *Haru* is perfect for middle-grade readers.

At its core, *Haru* is an adventure series about good versus evil, with central themes based around death and rebirth, growing up, love, and the sacrifices we make for those that we love.

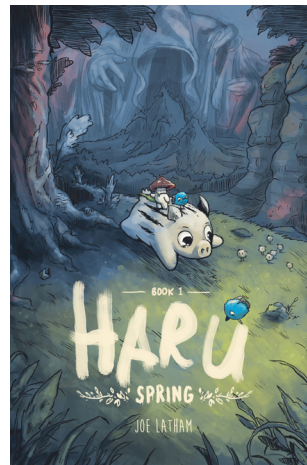
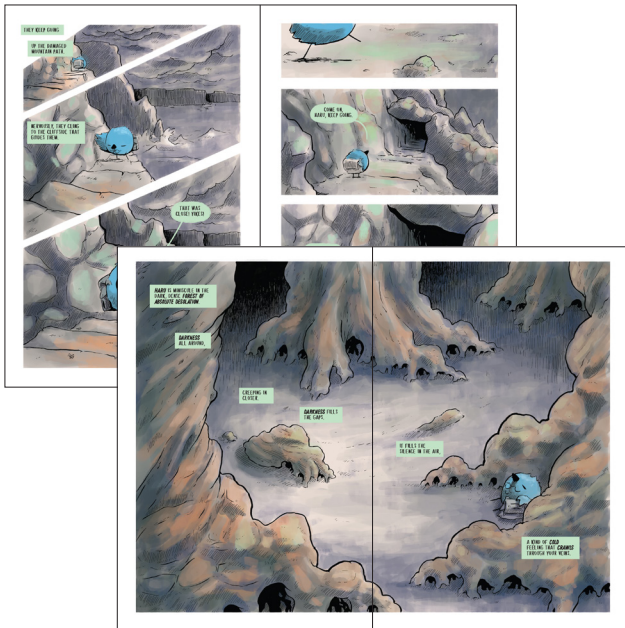

HARU: SPRING

Publication Date: March 2024
ISBN: 978-1-5248-8473



HARU: SUMMER

Publication Date: October 2024
ISBN: 978-1-5248-9374-3

Subject:
 Juvenile Fiction – Comics & Graphic Novels
 – Animals
 Juvenile Fiction – Social Themes –
 Adolescence & Coming of Age
 Juvenile Fiction – Comics & Graphic Novels
 – Fantasy

Price: \$14.99 USD
 Paperback, 152 x 229 mm
Age Range: 8–12

Translation Rights Sold to the Series:
 French French (Ankama), Spanish
 (La Cupula)

Final PDF Available: Now



HEIDI

A Graphic Novel

By Mariah Marsden, Ofride

Artist Ofride grew up in northern Italy, near the Alps, and brings her native landscape to vibrant life in this adaptation.

On top of engaging young readers in a classic story they might not have accessed otherwise, this graphic edition functions as a keepsake for adults who loved *Heidi* as children.

Discover the heartwarming magic of Johanna Spyri's beloved tale in this gorgeous graphic novel adaptation. From the author of the critically acclaimed *Anne of Green Gables: A Graphic Novel* comes another thoughtfully retold children's classic.

Publication Date: March 2025

ISBN: 978-1-52488-640-0

Price: \$12.99

Paperback, Pages, 160, 152 x 229 mm

Age: 8-12

Translation Rights Sold: French (Jungle-Steinkis), Spanish (Ediciones Maeva)

Final PDF Available: Now

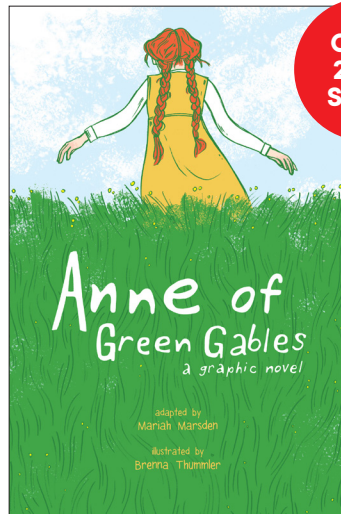

ANNE OF GREEN GABLES

"The spirit of Anne is alive and well in Mariah Marsden's crisp adaptation, and it's a thrill to watch as the beloved orphan rushes headlong through Brenna Thummler's heavenly landscapes. Together Marsden and Thummler conjure all the magic and beauty of *Green Gables*. Like Anne herself, you won't want to leave."

— Brian Selznick, author/illustrator of *The Invention of Hugo Cabret* and *The Marvels*

Publication Date: November 2010

ISBN: 978-1-44947-960-2

Paperback, 232 pages

Translation Rights Sold: Chinese simplified/China (Shanghai Insight Media), Danish (Staarup), Dutch (Uitgeverij Karmijn B.V.), French/Canada (Scholastic), French/World ex. Canada (City Comics), Hebrew (Keter), Italian (Il Castoro), Korean (reverted), Portuguese/Brazil (Ciranda), Portuguese/Portugal (2020 Editora)



THE SECRET GARDEN

First ever graphic novel adaptation!

ISBN: 978-1-52489-293-7

Paperback, 192 pages

Translation Rights Sold: Chinese simplified/China (Hunan Tianwen Animation & Comics), Portuguese/Portugal (Penguin Random House), Spanish (Ediciones Maeva)



Finnik the Furious

An Original Graphic Novel

By Josh Ulrich

Creator Josh Ulrich brings proven comics chops, with 47.7M+ views and 203K+ subscribers on Webtoon (Newman) as of June 2025, a YA graphic novel (*The Terrifying Tales of Vivian Vance, Razorbill 2024*), and colorist credit for *Adventure Time #9* from Kaboom.

What's tougher than slaying monsters? Keeping your baby sister alive to tell the tale.

Ten-year-old Finnik dreams of becoming a legendary monster hunter like his parents. But when he's told to stay behind and watch his baby sister, Finnik finds a clever loophole: why not do both?

With baby sister Tina strapped to his back, Finnik sets off on a prehistoric quest full of hungry beasts, epic battles, and unexpected dangers. The plan goes well . . . until a monster snatches Tina away! Finnik must discover the truth about what it really means to be legendary, and that heroes protect the people they love, no matter what.

A laugh-out-loud adventure comic full of prehistoric peril, sibling chaos, and unexpected heroism, for fans of *Barb the Last Berzerker*, *Cat Ninja*, and *Lucy & Andy Neanderthal*.

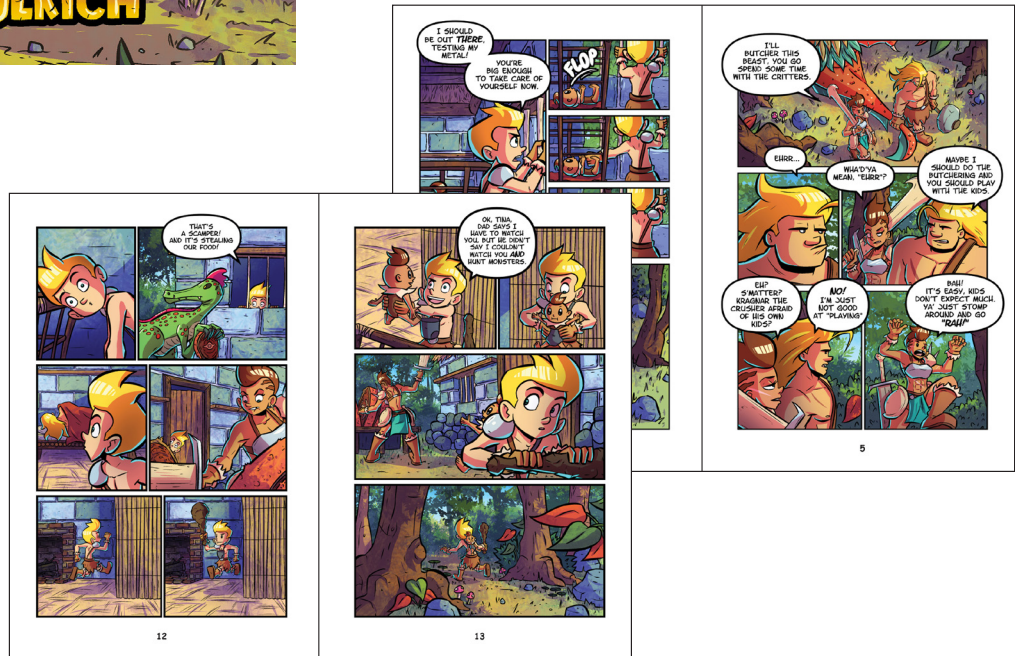

Subject:
 Juvenile Fiction – Comics & Graphic Novels – Fairy Tales, Folklore, Legends & Mythology
 Juvenile Fiction – Comics & Graphic Novels – Action & Adventure
 Juvenile Fiction – Comics & Graphic Novels – Humorous

ISBN: 979-8-88160-411-0
Price: \$12.99 USD
 Paperback, 176,152 x 229 mm
Age Range: 9–11

Translation Rights Sold: All rights available

Publication Date: June 2026
Final PDF Available: Now



The Spark Experiment

By Matthew K. Manning, Matthew Loux

The Spark Experiment is the brainchild of High Touch, High Tech, a global organization that works with over 16 million children worldwide annually to make science fun and accessible. High Touch, High Tech franchises exist in Vietnam, Singapore, China, Japan, South Korea, Qatar, UAE, Turkey, Nigeria, and Morocco. (www.sciencemadefun.net)

This story features 18 experiments that are can easily be recreated by kids and their teachers or parents. The story goes over how they work, and back matter includes resources to videos of the activities for additional tips and information. Activities and experiments include how to make slime, creating an electromagnet, making paper rockets, and creating a bird feeder.

When fifth grader David Patel and his second-grade sidekick Marta Martinez uncover a science experiment gone wrong, they find themselves transported to the Micro Universe, a weird world inside our own that doesn't obey the laws of conventional physics. While they're able to return home thanks to the help of a strange little creature named Spark, the pair doesn't realize that they've led a group of nefarious beings called Negatrons back to our world in the process

Using 18 real do-it-yourself science experiments that readers can try at home, David, Marta, and Spark must save their small town from an invasion of these energy-leeching Negatrons, all the while learning how to "spark" their own imaginations. This is a new graphic novel is perfect for kids interested in hands-on activities and science fiction adventures!

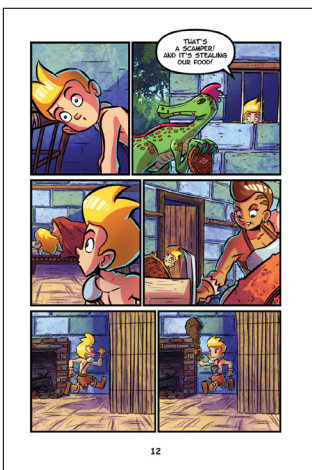

Subject:
 Juvenile Fiction – Comics & Graphic Novels – Science Fiction
 Juvenile Fiction – Comics & Graphic Novels – Action & Adventure
 Juvenile Fiction – Comics & Graphic Novels – Humorous

ISBN: 979-8-88160-192-8
Price: \$12.99 USD
 Paperback, 144,152 x 229 mm
Age Range: 8-10

Translation Rights Sold: All rights available

Publication Date: April 2026
Final PDF Available: Now



Speed Reader

By Matthew Cody, Zach Giallongo

Matthew Cody is the author of the bestselling *Cat Ninja* series and Zack Giallongo is a *New York Times* bestselling illustrator

The story's focus on a slow-paced reader who gains the power of super speed (and eventually learns why speed isn't everything) makes it a perfect choice for kids still building confidence as readers.

Zander Fast is always last—last to complete an assignment, last to finish reading, and last to the bus. Even worse, his Great Uncle Merv is constantly embarrassing him with his cheesy catchphrases and tall-tale stories. But when Zander receives a mysterious book in the mail, all of that changes. Suddenly, Zander has the speed (and popularity) he's always wanted—and Uncle Merv's stories no longer seem so far-fetched.

Between navigating the perils of middle school and balancing his newfound powers with his studies, Zander, his best friend Tanya May, and his trusty dog Spike must protect their hometown as it transforms into a wacky world of ex-heroes and villains. Will a mind-controlling villain have his way with the people of Cape City? Or will a new generation of heroes emerge to defeat him?



Subject:
 Juvenile Fiction – Comics & Graphic Novels
 – Action & Adventure
 Juvenile Fiction – Comics & Graphic Novels
 – Superheroes
 Juvenile Fiction – Comics & Graphic Novels
 – Humorous

ISBN: 978-1-52488-639-4
Price: \$12.99 USD
 Paperback, 160,152 x 229 mm
Age Range: 8-12

Translation Rights Sold: All rights available

Publication Date: March 2026
Final PDF Available: Now

“Cute critters, compassionate kids, and community—what’s not to love?”
—Kirkus Reviews

Animal Rescue Friends

At the Animal Rescue Friends shelter, everyone is looking for a way to belong—kids and animals alike.

A diverse cast of characters lets kids take a walk in someone else’s shoes—or paws—to develop compassion and an understanding of differences.



Also Available:

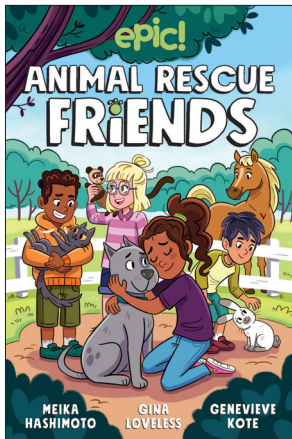

ISBN: 978-1-5248-6734-8

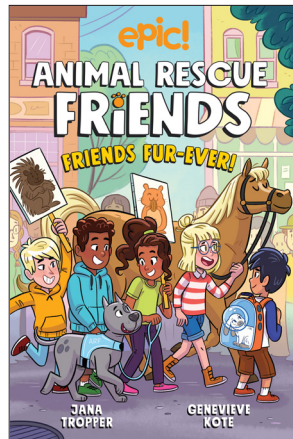

ISBN: 978-1-5248-7584-8

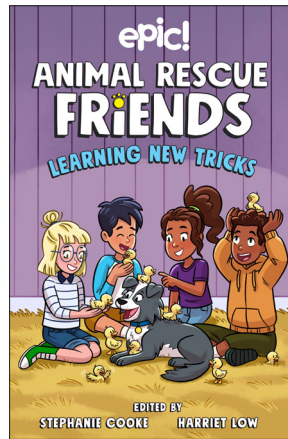

ISBN: 978-1-5248-8234-1

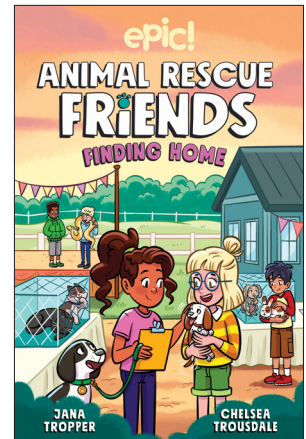

ISBN: 978-1-5248-8875-3

Age Range: 8–10

Translation Rights Sold: Slovakian (Albatros Media)

Final PDF Available: All titles available



Dustin Brady writes books for kids who think they hate reading. His *Trapped in a Video Game* and *Escape from a Video Game* series have sold over two million copies because—as it turns out—there are a lot of kids who think they hate reading.

TRAPPED IN A VIDEO GAME: 5 book series about Jesse Rigby and the wild adventures he encounters while trapped inside different video games.



TRAPPED IN A VIDEO GAME

ISBN: 978-1-44949-486-5
Paperback, 144 pages

Jesse and his friend Eric are hunted by a man-size praying mantis while stuck in the video game *Full Blast*.



TRAPPED IN A VIDEO GAME: INVISIBLE INVASION

ISBN: 978-1-44949-489-6
Paperback, 160 pages

Jesse battles a Bigfoot, a velociraptor and a flame-throwing bat all while invisible and trapped in the game *Go Wild*.



TRAPPED IN A VIDEO GAME: ROBOTS REVOLT

ISBN: 978-1-44949-515-2
Paperback, 176 pages

Jesse accidentally releases robot villains from *Super Bot World 3* into the real world and now must figure out how to save it!



TRAPPED IN A VIDEO GAME: DOOM ISLAND

ISBN: 978-1-44949-518-3
Paperback, 168 pages

Jesse turns into a superspy to outsmart an android, outlast a drone, outswim an 8-bit shark, and figure out who is responsible for trapping gamers in video games!

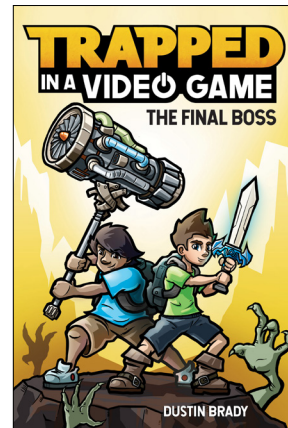

TRAPPED IN A VIDEO GAME: FINAL BOSS

ISBN: 978-1-44949-573-2
Paperback, 208 pages

Jesse and Eric have ten minutes to save the world all while battling fire-breathing pterodactyls, angry green giants, and unicorns that shoot lasers out of their hooves!

Age Range: 8–10

Translation Rights Sold: Albanian (Bota Shqiptare), Catalan (Planeta), Chinese simplified/China (Beijing S&T), German (Loewe), Italian (Il Castoro), Korean (Book 21), Polish (Muza), Portuguese/Brazil (Faro Editorial), Romanian (Editura Paralela 45), Slovakian (reverted), Spanish (Planeta), Turkish (Beyaz Balina)

Final PDF Available: All titles available



ESCAPE FROM A VIDEO GAME: Young gamers control the action in this interactive series. Readers can “choose their own path” with more than 30 possible endings and an unlockable bonus story at the end of each book.

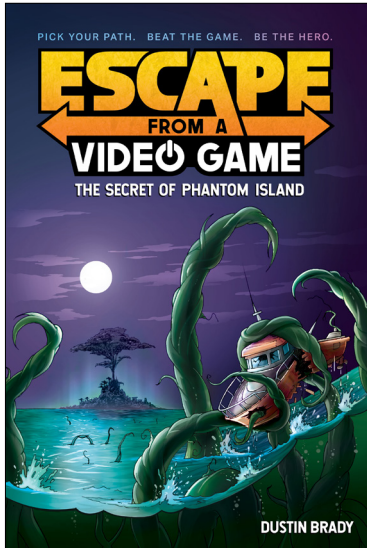

**ESCAPE FROM A VIDEO GAME:
THE SECRET OF PHANTOM ISLAND**

ISBN: 978-1-52485-880-3
Paperback, 176 pages

Outsmart enemies, solve puzzles, and explore mysteries of the island!



**ESCAPE FROM A VIDEO GAME:
MYSTERY ON THE STARSHIP
CRUSADER**

ISBN: 978-1-52485-884-1
Paperback, 192 pages

Will you survive a high-stakes challenge inside a video game and win a million dollars, or will you fall victim to a crewmate?



**ESCAPE FROM A VIDEO GAME:
THE ENDGAME**

ISBN: 978-1-52487-195-6
Paperback, 192 pages

Will you be crowned the Greatest Supervillain of All Time?

Age Range: 8–10

Translation Rights Sold: Catalan (Planeta), Czech (Euromedia), Danish (Gads), Dutch (De Fontein), Spanish (Planeta)

Final PDF Available: All titles available



ADVENTURES IN A VIDEO GAME: Standalone adventures that can be read in any order!



**ADVENTURES IN A VIDEO GAME:
DON'T CLIMB THIS MOUNTAIN**

ISBN: 978-1-52487-707-1
Paperback, 192 pages

Archie Maloney accepts a mountain-climbing challenge inside a video game and brings along some friends to battle digital monsters, glitching terrain, and betrayal!



**ADVENTURES IN A VIDEO GAME:
MY FRIEND FROM THE FUTURE**

ISBN: 978-1-52489-035-3
Paperback, 192 pages

What would you do if all of your friends were kidnapped by video game aliens at your birthday party?

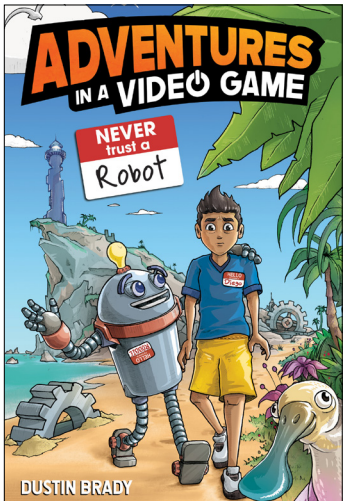

**ADVENTURES IN A VIDEO GAME:
NEVER TRUST A ROBOT**

ISBN: 979-8-88160-226-0
Paperback, 224 pages

Diego arrives on the beautiful island of Guntir but can't remember how he got there and has two hours to save the island from destruction!



**ADVENTURES IN A VIDEO GAME:
THE GREAT PIE HEIST**

ISBN: 979-8-88160-228-4
Paperback, 192 pages

Harper and her friends become masters of disguise, deception, forgery, arts, crafts, and banjos to save their favorite game.

Age Range: 8-12

Translation Rights Sold: All rights available

Final PDF Available: All titles available



Gyro and the Argonauts!

Aka The Best Book Ever Written* (*About a Kid Named After a Sandwich)

By Joshua Pruett, Amanda Castillo

“With big laughs, big heart, and big monsters, *Gyro and the Argonauts* is timeless fun for everyone!” – Max Brallier, sandwich expert and author of the #1 New York Times bestselling series *The Last Kids on Earth*

“*Gyro and the Argonauts* is a hilarious, adventurous, and nail-biting twist on Greek mythology tropes with a well-developed cast of zany characters ... *Gyro* is the new hero we all need: courageous, monster friending, and true to himself.” – Demetra Brodsky, award-nominated author of *Last Girls* and *Dive Smack*

New York Times bestselling author!

Gyro and the Argonauts tells the totally (mostly) true story of the first “Greek Geek,” a super fanboy vineyard grape-squisher named Gyro (like the sandwich), who learns there’s so much more to the maligned monsters of mythology (such as the CYCLOPS, the MINOTAUR, and even MEDUSA herself), and so much less to his favorite heroes (including Perseus, Heracles, and Pegasus) than he ever dreamed. All this happens when he joins the crew of the intrepid Argonauts and learns to never meet your heroes (think: *The Avengers*, if the Avengers were all buttheads).

This side-splitting, voice-driven, and SUPER OUTRAGEOUS series follows Gyro (pronounced hee-roh) on his journey to become a hero.

In addition to fun, pertinent, and timeless themes, readers will also learn fascinating facts from Greek and Roman mythology (like the fact that Bellerophon, not Perseus, rode Pegasus the flying horse—and no, dear reader, we didn’t know that, either!).

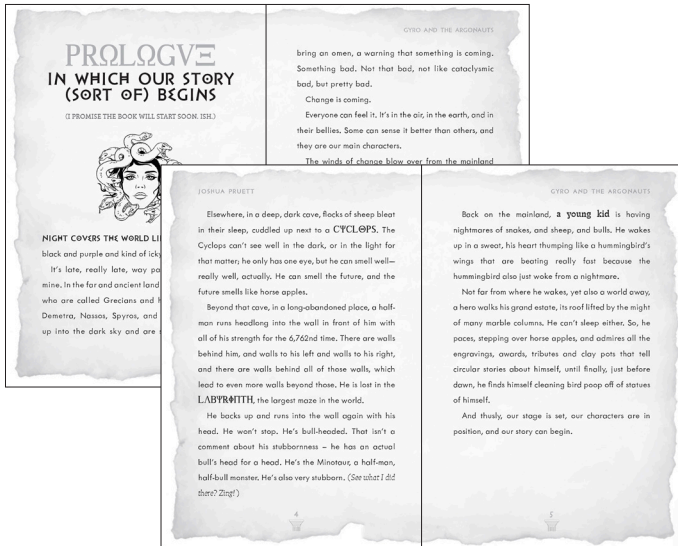

Subject:
Juvenile Fiction – Legends, Myths, Fables – Greek & Roman
Juvenile Fiction – Monsters
Juvenile Fiction – Action & Adventure
Juvenile Fiction – Humorous

ISBN: 978-1-52488-641-7
Price: \$12.99 USD
Paperback, 272, 140 x 203 mm
Age Range: 10–12

Translation Rights Sold: Spanish/Latin America (V&R Editores)

Publication Date: June 2026
Final PDF Available: Now



Hopscotch Girls Presents: Spotlight on Zari

By Hopscotch Girls, Melissa Foley, Misa Dessalines,
Luna Valentine

This adorably illustrated third book in the hit series celebrates girl power, entrepreneurship, friendship, and chasing your dreams.

Meet Zari Tyler—prima ballerina, star performer, and the ultimate friend. She's on a roll—not only is she in a performance of *The Nutcracker*, but she's been cast as the lead for her school's production of *Annie, Jr.*! Now she just has to keep up with school rehearsals, dance practice, and helping market the musical with her best friend Mia and her new friend Sarah. Easy! But collaborating with friends isn't as easy as it sounds, and with both performances coming up, as well as this maybe being her last year going to the same school as her friends, it feels like time is running out faster and faster. Can Zari juggle it all, or is it already curtain call for her?



Also Available:



Meet Mia...entrepreneur and business consultant to her classmates!

ISBN: 978-1-52488-743-8
Paperback, 208 pages



Mia hires an assistant and learns the challenging but rewarding bath of balancing her business, hiring an assistant, and making sure there's still time for fun and friendship.

ISBN: 978-1-52488-744-5
Paperback, 216 pages

Subject:

Juvenile Fiction – Girls & Women
Juvenile Fiction – Social Themes – Self-Esteem & Self-Reliance
Juvenile Fiction – Business, Careers, Occupations
Juvenile Fiction – Performing Arts - Dance

ISBN: 978-1-5248-8745-2

Price: \$12.99 USD

Paperback, 144, 140 x 203 mm

Age Range: 8-10

Translation Rights Sold: All rights available

Publication Date: October 2025

Final PDF Available: Now

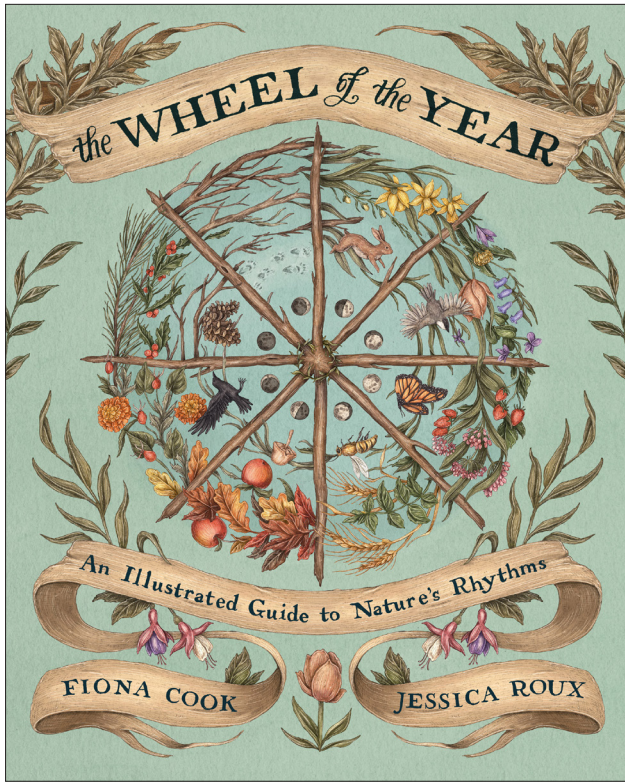

Wheel of the Year

An Illustrated Guide to Nature's Rhythms

By Fiona Cook, Jessica Roux

New York Times bestseller!

"This book is, in a word, immaculate." – Kirkus Reviews

Over 85,000 copies sold!

Blending nature connection with art, poetry, and myth, *The Wheel of the Year* conveys the magic and beauty of ancient traditions and encourages young family members to notice, care for, and celebrate the natural world around them. A thoughtful reference and gift book suitable for either leisure reading or homeschooling, it is geared toward younger readers but enjoyable for those of all ages seeking a deeper connection to nature's traditions.

Each "spoke" in *The Wheel of the Year* marks an important turning point: the winter and summer solstices, the spring and fall equinoxes, and the festivals of seeding, growing, and harvesting that arrive in between. Within each section, enjoy:

- An overview of the holiday and its significance in cultures around the world
- A sensory scavenger hunt for sights, sounds, and smells the season
- Ideas for a seasonal altar using objects from nature
- Themed crafts, rituals, games, and recipes

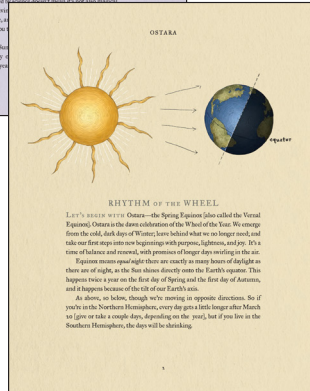

Subject:
 Juvenile Nonfiction – Holidays & Celebrations – Other, Non-Religious
 Juvenile Nonfiction – Reference – Encyclopedias
 Juvenile Nonfiction – Social Science – Folklore & Mythology
 Juvenile Nonfiction – Social Science – Customs, Traditions, Anthropology

ISBN: 978-1-52487-480-9
Price: \$21.99 USD
 Hardcover, 256, 203 x 254 mm
Age Range: 8-12

Translation Rights Sold: Bulgarian (Znaci), Italian (Mondadori Electa), Portuguese/Brazil (Darkside), Romanian (Editura Paralela 45), Ukrainian (Arthuss)

Publication Date: October 2023
Final PDF Available: Now



Trailblazers

The Unmatched Story of Women's Tennis, Young Readers Edition

By Billie Jean King, Jolie C. Matthews, Alexandra Badiu

Billie Jean King is regarded as one of the greatest tennis players and activists of all time!

Cross-generational appeal!

Celebrate the incredible achievements of women in tennis with this beautifully illustrated collection of biographies. Young readers will be captivated by the stories and inspiring records of trailblazing athletes like Serena and Venus Williams, Billie Jean King, Naomi Osaka, and many more.

This young reader's edition is packed with real facts about the history of tennis and features brand-new illustrations by the renowned artist Alexandra Badiu.

Through a powerful blend of art, history, and inspiring stories, this book aims to educate, inspire, and empower readers to chase their dreams and achieve their goals.

Featured Tennis Icons Include:

- Billie Jean King
- Serena Williams
- Venus Williams
- Naomi Osaka
- Diede de Groot
- Ash Barty
- and many more!

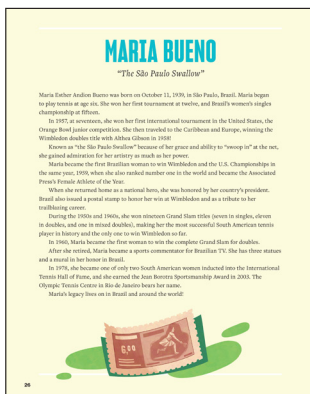
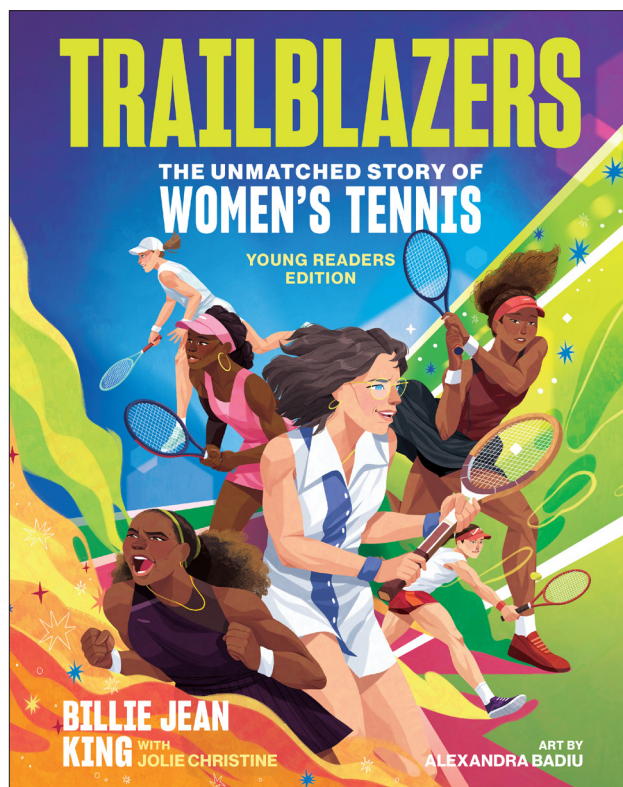

Subject:
Juvenile Nonfiction – Biography & Autobiography – Sports & Recreation
Juvenile Nonfiction – Sports & Recreation – Racket Sports
Juvenile Nonfiction – Biography & Autobiography – Women

ISBN: 978-1-52488-360-3
Price: \$21.99 USD
256, 203 x 254 mm
Age Range: 8-12

Translation Rights Sold: All rights available

Publication Date: August 2025
Final PDF Available: Now

More than 330,000 copies sold!

Over 200K sold to Scholastic Book Fairs!

2023 American Library Association Best Graphic Novel for Children Reading List Honoree

Perfect for fans of kawaii art, Labubu, Hello Kitty, Animal Crossing, Pokemon, and more!

Dyslexia-friendly font! Book #4 is coming Spring 2027!



POCKET PEACHES

ISBN: 978-1-52487-864-1

Peaches befriends someone new to her neighborhood, a mysterious cat named Taro!



POCKET PEACHES AT THE FAIR

ISBN: 978-1-52487-865-8

Peaches and her pals go to the Moonberry Jubilee Fair!



POCKET PEACHES GAME ON

ISBN: 978-1-52489-615-2

Taro learns to navigate unexpected life changes while maintaining virtual friendships.

COLORING BOOKS AND A JOURNAL TOO!



THE OFFICIAL POCKET PEACHES COLORING BOOK

ISBN: 978-1-52489-614-0

Price: \$15.99

112 pages, 190 x 240 mm

Finished PDF Available: Now

Translated Rights Sold: Finnish (WSOY)

Includes 100 stickers!



SWEET & SIMPLE POCKET PEACHES COLORING

ISBN: 979-8-88161-021-0

Price: \$14.99

80 pages, 209 x 209 mm

Finished PDF Available: Now

Translated Rights Sold: All rights available

Perfect for fans of CocoWyo!



POCKET PEACHES JOURNAL

ISBN: 979-8-88161-374-7

Price: \$12.99

142 lined pages

Finished PDF Available: Now

Translation Rights Sold: All rights available

Illustrated "Belongs To" Page, woodfree paper with no ink bleed through

Translation rights sold to the graphic novel series:
Czech (Albatros), Dutch (ZNU), Finnish (WSOY),
Polish (Zielona Sowa)

Age range: 7-9

152 x 229 mm, 80 pages

Welcome to the Forest

The Lake Trip

By Katie Risor

“Risor’s soft artwork, in gouache and colored pencil, nicely carries the episodic stories, three in total, filled with gentle fantasy forest creatures with rounded shapes and expressive faces, and the autumnal forest setting and warm palette will appeal to kids who love Halloween but don’t want to be really scared.” - *Booklist*, for *Welcome to the Forest: The Harvest Party*

Mossman, Wallace, and friends are off on a lakeside adventure!

Perfect for emerging readers and fans of Studio Ghibli’s whimsical worlds, this early reader graphic novel features:

- Fun nonfiction facts about lakes and their natural wonders
- Dyslexia-friendly font for accessible reading
- Simple dialogue and sight words for beginning readers and ESL learners
- Gorgeous hand-painted illustrations in a distinctive, cozy style
- Adorably quirky characters that will delight fans of *Pocket Peaches*, *Brambly Hedge*, *Calico Critters*, and *Labubu* collectors

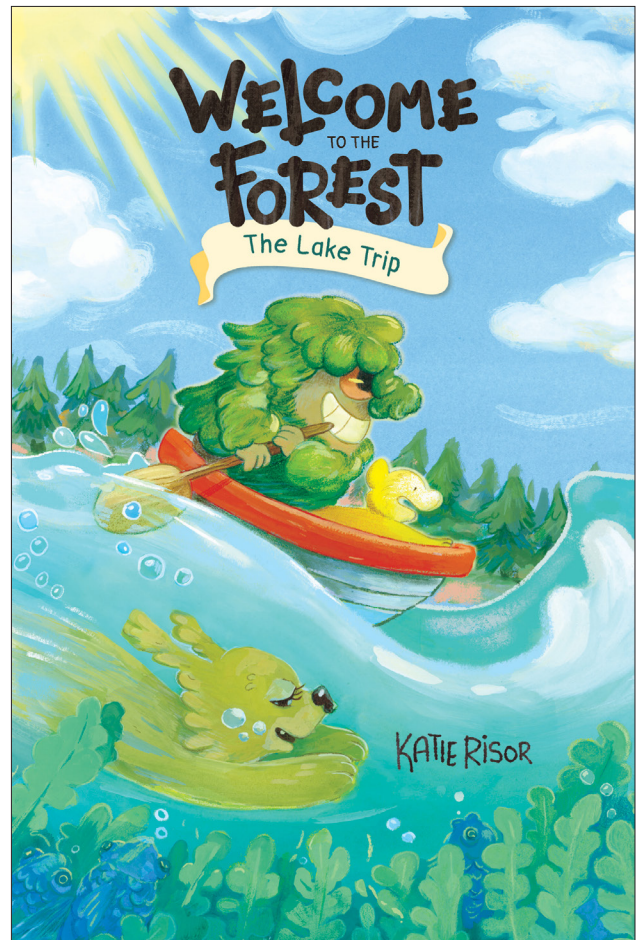

Also Available:

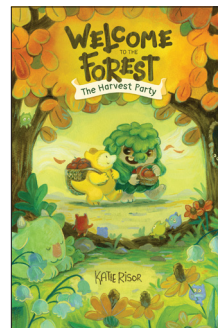

**Welcome to the Forest:
The Winter Book:**
Coming November 2027!

**Welcome to the Forest:
The Spring Book:**
Coming April 2028!

ISBN: 978-1-52489-428-3

Three bite-sized stories
perfect for the autumnal
harvest season!

Subject:
Juvenile Fiction – Comics & Graphic
Novels – Fairy Tales, Folklore, Legends &
Mythology
Juvenile Fiction – Comics & Graphic Novels
– Fantasy
Juvenile Fiction – Readers – Chapter Books

ISBN: 978-1-52489-429-0
Price: \$11.99 USD
Hardcover, 144, 80,159 x 235 mm
Age Range: 6–9

Translation Rights Sold: All rights available

Publication Date: June 2026

Final PDF Available: Now



More exciting stories and laughs for early readers

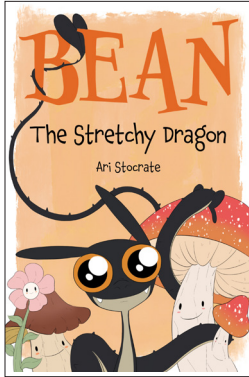

BEAN THE STRETCHY DRAGON

ISBN: 978-1-52488-101-6
Price: \$11.99
96 pages, 152 x 229 mm
Ages: 7-10
Translation Rights Sold: German (Friedrich Oetinger GmbH)



KITTEN NINJA

ISBN: 978-1-52488-819-0
Price: \$11.99
80 pages, 152 x 229 mm
Ages: 6-9
Translation Rights Sold: All rights available



KITTEN NINJA BRAVER THAN EVER

ISBN: 978-1-52489-624-9
Price: \$11.99
80 pages, 152 x 229 mm
Ages: 6-9
Translation Rights Sold: All rights available.



SLICE OF MALLOW

ISBN: 978-1-52488-083-5
Price: \$11.99
80 pages, 152 x 229 mm
Ages: 6-9
Translation Rights Sold: Romanian (Editura Paralela 45)



SLICE OF MALLOW SECOND SLICE

ISBN: 978-1-52488-084-2
Price: \$11.99
80 pages, 152 x 229 mm
Ages: 6-9
Translation Rights Sold: All rights available



KITTY AND DRAGON

ISBN: 978-1-52486-100-1
Price: \$7.99
104 pages, 152 x 229 mm
Ages: 4-8
Translation Rights Sold: Romanian (Editura Paralela 45).

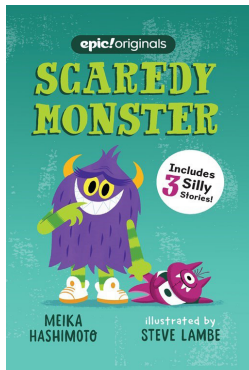

SCAREDY MONSTER

ISBN: 978-1-52485-522-2
Price: \$7.99
104 pages, 152 x 229 mm
Ages: 4-8
Translation Rights Sold: All rights available

QUIRK  **BOOKS**

An Imprint of Andrews McMeel Publishing



Dog Loves Baby

By Natalie Nelson

In the next board book in the beloved series from Natalie Nelson, Dog and Baby are back with a sweet ode to what it means to love someone all year long! Simple rhyming text and bright illustrations make *Dog Loves Baby* an ideal gift for the youngest readers.

Love is in the air! In this sweet book, Dog sniffs out the meaning of love and tries to figure out why there are so many paper hearts to chew. Of course, Baby is on the case, too—and they just might discover that love is all around them.

For more in this beloved series, delight in new experiences all year long with *Dog's First Baby* and *Cat's First Baby*, and celebrate the holiday spirit with *Dog's First Christmas* and *Cat's First Halloween!*



NATALIE NELSON is an illustrator, picture book maker, and collage artist. Her previous titles include, *Dog's First Baby*, *Cat's First Baby*, and *Holiday!*. She lives in Atlanta, Georgia, with her family, and you can visit her online at natalieknelson.com

Dog and Baby are back with a sweet ode to love!

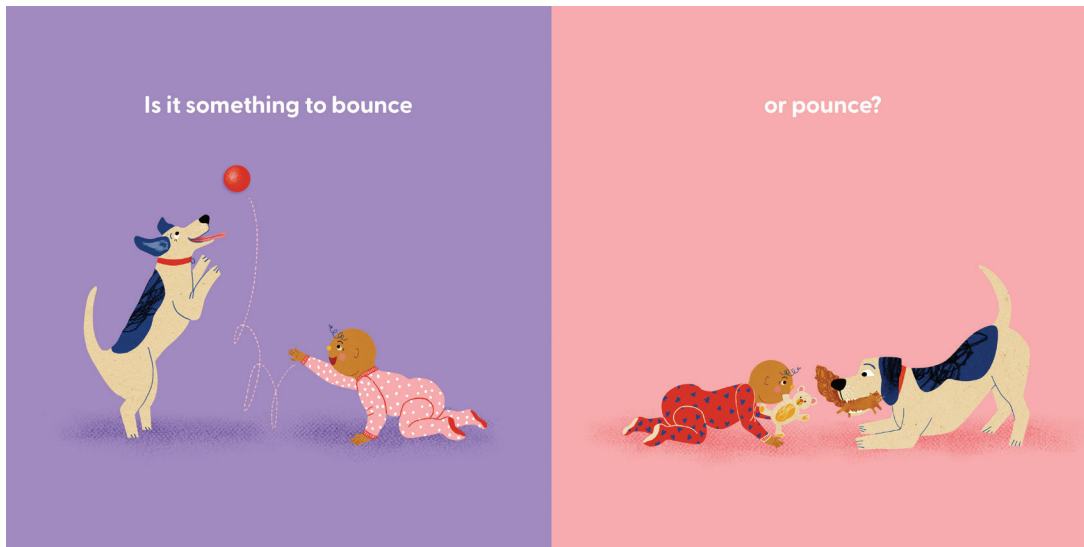

Subject:
 Juvenile Fiction - Holidays & Celebrations - Valentine's Day
 Juvenile Fiction - Animals - Dogs
 Juvenile Fiction - Animals - Pets

ISBN: 978-1-68369-452-6
 \$9.99 USD
 7 x 7, 28 pages
 Board
Reading Level and Age Range: 2-5 years

Rights: All World Rights Available.

Publication Date: December 2, 2025

Final PDF Available: Now

ABOUT THE SERIES

Dog is curious, and Cat is skeptical. Whether they're meeting a new baby or celebrating a holiday or milestone, you can count on Dog and Cat to sniff out answers and find wonder in new experiences in this playful board book series for babies and toddlers by Natalie Nelson.

Coming soon: *Dog's First Day of School!*

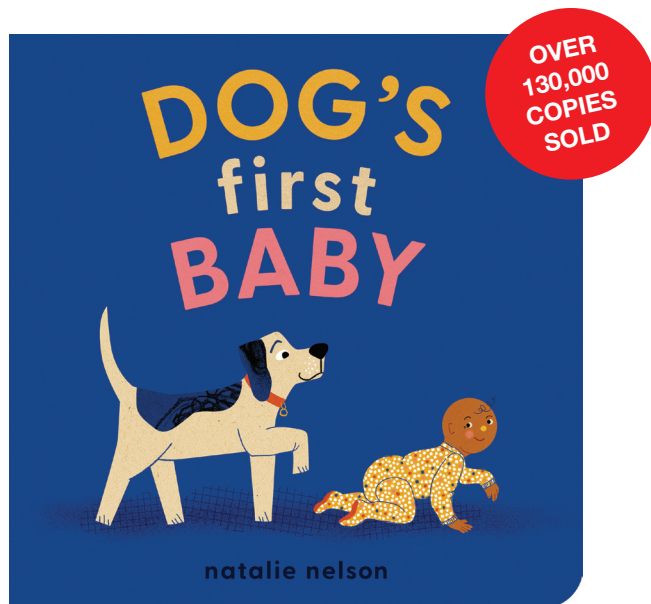
**Dog's First Baby**

October 2021

French (Le Père Castor)

Italian (Il Castoro)

**Cat's First Baby**

March 2022

All World Rights Available

**Dog's First Christmas**

October 2024

All world rights available.

**Cat's First Halloween**

August 2025

All world rights available.



Let's Find Yaya and Boo on the Go!

By Andrew Knapp

Cars, trucks, Yaya, and Boo!

Is that Yaya taking a ride in a fire truck, and Boo hiding behind a boat? Can you spot the dogs taking a bus ride to school, or checking out a construction site? The next installment of Andrew Knapp's beloved Find Momo series highlights things that go, such as cars, trucks, airplanes, bikes, and more!

Search for Yaya and Boo in unlikely places all over town and learn new words by finding objects in each lovingly photographed scene packed with delightful details.

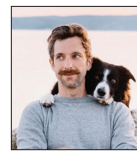

ANDREW KNAPP is a writer, illustrator, graphic designer, and photographer currently based in Vancouver. Previous books include *Let's Find Momo!*, *Let's Find Momo Outdoors!*, *Let's Find Yaya and Boo at Home!*, and *Find Momo Everywhere*. Say hello at letsfindmomo.com.

PLAY HIDE-AND-SEEK WITH
TWO LOVABLE DOGS AND
TWELVE EXCITING VEHICLES
IN THE LATEST BOARD BOOK
BY ANDREW KNAPP!

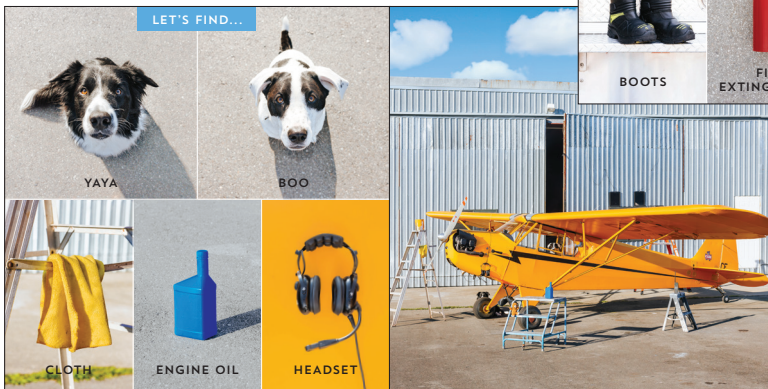

Subject:
Juvenile Nonfiction - Animals - Dogs
Juvenile Nonfiction - Games &
Activities - General
Juvenile Nonfiction - Transportation
- General

ISBN: 978-1-68369-486-1
\$10.99 USD
8 x 8, 24 pages
Board
Reading Level and Age Range: 2-5

Rights Sold:
French (Grandes Personnes)

Publication Date: September 2025
Final PDF Available: Now

ABOUT THE SERIES

Momo, Yaya, and Boo love to play hide-and-seek with you! Look for these adorable pup pals hiding in joyful scenes photographed by their best friend, Andrew Knapp.



Let's Find Momo!

April 2017

Dutch (WPG Kindermedia), Estonian (Koolibri), French (Grandes Personnes), German (Fischer), Italian (Topipittori), Polish (Lumi)



Let's Find Momo Outdoors!

May 2021

French (Grandes Personnes), Italian (Topipittori), Polish (Lumi)



Let's Find Yaya and Boo at Home!

August 2023

French (Grandes Personnes), Polish (Lumi)



Find Momo Everywhere

February 2024

Simplified Chinese (Jiangsu Phoenix Children's Publishing House)

THIS TIME OF YEAR: A NEW PICTURE BOOK SERIES

About the books

Embrace the rhythm of the seasons with this celebration of the best each time of year has to offer: *Snuggle Season*, *Growing Season*, *Swimming Season*, and *Sweater Season*.

Some books focus all their seasonal attention on holidays and their respective traditions, rituals, and preparations. Others work to shape young readers' understanding of months and calendars and how the seasons connect with so many other aspects of our natural world. *Snuggle Season* and the subsequent books highlight the cozy daily rituals that mark our lives, and especially children's lives. In *Snuggle Season* delight in the coziness of winter! In *Growing Season*, celebrate the wonders of spring! In *Swimming Season*, dive into the joys of summer! In *Sweater Season*, embrace the crisp, cool days of autumn!

JAIMIE MacGIBBON is a children's book author and illustrator living in the mountains of British Columbia, Canada, where she gets to experience the full range of seasons. From waist-deep snow, to mud and blossoms, to scorching summers and golden autumns, Jaimie looks forward to celebrating each new season with her family. This is her author-illustrator debut.





Snuggle Season

By Jaimie MacGibbon

Delight in the coziness of winter with this charming picture book, the first in a series about the simple joys and daily rituals of each changing season!

Winter, crisp and cold, is here,
so we snuggle up this time of year.

Can't get out of bed snuggles, curled up by the fire snuggles, waiting for the baking snuggles... A simple yet magical day unfolds as two siblings wake up to chilly weather, falling snow, and opportunities for snuggles of all kinds!

With warm, rhythmic text and inviting illustrations, *Snuggle Season* explores the cozy, hidden wonders of winter. This timeless read-aloud will be a family favorite each year when snuggle season rolls around.

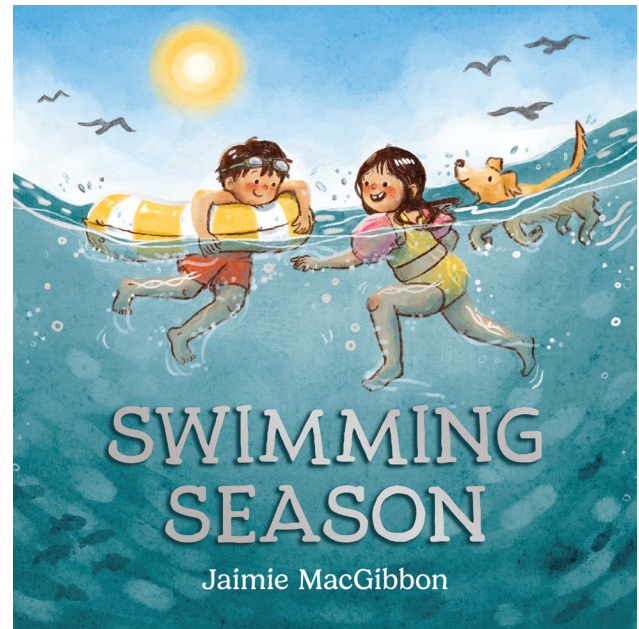

Swimming Season

By Jaimie MacGibbon

Splash into the thrills of summer with this delightful picture book from a series about the simple joys and daily rituals of each changing season!

Summer, full and bright, is here,
so we swim and soar this time of year.

Warm sand, splashing water, and sunny weather: it's time for *Swimming Season*! An ode to the magic of endless summer days, Jaimie MacGibbon's rhythmic text and joyful illustrations celebrate the best that summer has to offer. A pitch-perfect read-aloud, this story is sure to become a family favorite each year when summer rolls around.

Swimming Season is the second book in the new This Time of Year series, about the memorable daily rhythms of childhood—and through them, sweet assurances of love—that emerge as the seasons shape our lives.

Snuggle Season

Subject:

Juvenile Fiction - Concepts - Seasons
Juvenile Fiction - Social Themes - New Experience
Juvenile Fiction - Family - General

ISBN: 978-1-68369-512-7

\$18.99 USD

9 x 9, 32 pages,
4c hardcover with jacket

Age Range: 2-5

Rights Sold: All world rights available.

Publication Date: October 14, 2025

Final PDF Available: Now

Swimming Season

Subject:

Juvenile Fiction - Concepts - Seasons
Juvenile Fiction - Social Themes - New Experience
Juvenile Fiction - Family - General

ISBN: 978-1-68369-516-5

\$18.99 USD

9 x 9, 32 pages,
4c hardcover with jacket

Age Range: 2-5

Rights Sold: All world rights available.

Publication Date: April 14, 2026

Final PDF Available: November 2025

ARC PDF Available: Now

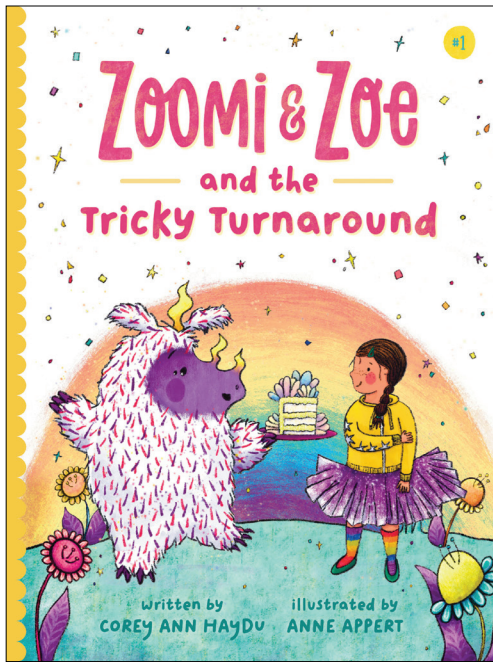

Zoomi and Zoe and the Tricky Turnaround

By Corey Ann Haydu, illustrated by Anne Appert

In GlumbleGibble, one ritual is certain: When something hard happens, it's called a Tricky Turnaround. And when it does, a Helpful Human from the "real" world will help you through it.

But when Zoomi's best friend moves away and Zoe arrives, she doesn't seem very happy. Or helpful. Or excited about the party Zoomi threw for her—complete with toothbrushes and tuba music. In fact, Zoe may be in a Tricky Turnaround of her own. Can Zoomi and Zoe help each other with the trickiest parts of growing up, like saying goodbye to friends and making new ones?

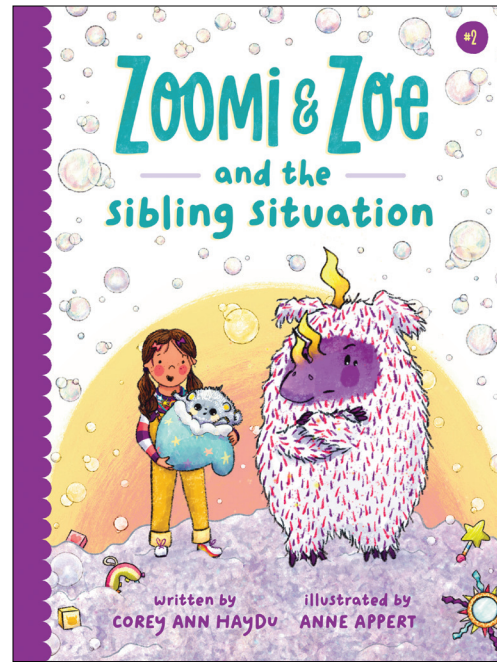

Zoomi and Zoe and the Sibling Situation

By Corey Ann Haydu, illustrated by Anne Appert

Zoomi and Zoe were proud to conquer their first Tricky Turnaround together, but more changes are around the corner: They're both going to be big siblings!

Zoe is excited and Zoomi is intrigued, but they soon learn the truth. Babies might be cute, but they're also rude, loud, and stinky—and they don't even want to lick blueberry-jam paint! Can these friends hatch a plan to overcome their sibling situation together?

Sparkly, silly, and perfect for early readers, Corey Ann Haydu and Anne Appert's winning series tackles life's first big changes with whimsy and heart.

Zoomi and Zoe and the Tricky Turnaround

Subject:
Juvenile Fiction - Social Themes - Friendship
Juvenile Fiction - Social Themes - New Experience
Juvenile Fiction - Fantasy - Portals & Alternate Worlds

ISBN: 978-1-68369-458-8
\$15.99 USD

6 x 8, 96 pages,
4c unjacketed hardcover

Age Range: 4-8
Rights Sold:
Audio: Dreamscape
Translation: Available from Quirk
Film/TV: Reserved by Author (High Line Literary)

Publication Date: June 2025
Final PDF Available: Now

Zoomi and Zoe and the Sibling Situation

Subject:
Juvenile Fiction - Social Themes - Friendship
Juvenile Fiction - Social Themes - New Experience
Juvenile Fiction - Fantasy - Portals & Alternate Worlds

ISBN: 978-1-68369-460-1
\$15.99 USD

6 x 8, 96 pages,
4c unjacketed hardcover

Age Range: 4-8
Rights Sold:
Audio: Dreamscape
Translation: Available from Quirk
Film/TV: Reserved by Author (High Line Literary)

Publication Date: August 2025
Final PDF Available: Now

Zoomi and Zoe and the Camp Catastrophe

Written by Corey Ann Haydu

Illustrated by Anne Appert

Will Zoomi and Zoe have the best summer ever . . . or the worst?

Zoomi and Zoe are spending the summer at Camp GlumbleGibble! Zoomi can't wait to show Zoe how to make friendship bracelets out of stars and stay up late talking in their cabin that tells knock-knock jokes.

But Zoe seems to have more in common with the Happy Helpful Humans at camp—especially one named Charlotte—than she does with Zoomi. Can Zoomi and Zoe salvage the summer, and their friendship, after a big blowup?



COREY ANN HAYDU is the author of many critically acclaimed books for young readers, including *Eventown* and *A Place for Feelings*. Corey is a graduate of the New School's Writing for Children MFA program, and a faculty member of the Vermont College of Fine Arts' MFA in Writing for Children and Young Adults program. She lives in Brooklyn with her husband and two young daughters.

ANNE APPERT is an illustrator and storyteller who uses humor and whimsy to inspire kids to dream big and love themselves. Their previous books include *Blob* and *What If You Wish?*. You can visit Anne at anneappert.com.

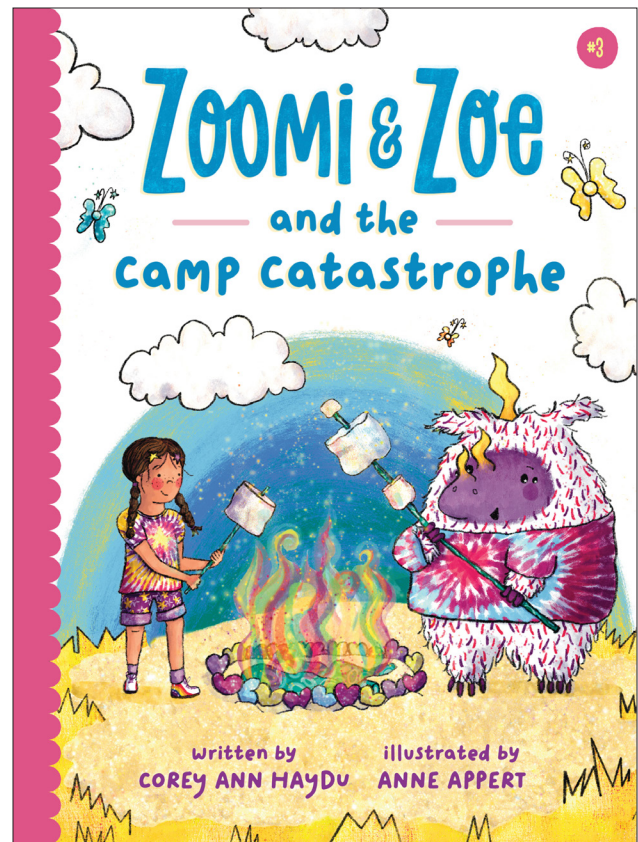

Princess in Black meets *Monsters, Inc.* in a zany, heartwarming series for early readers 4-8!

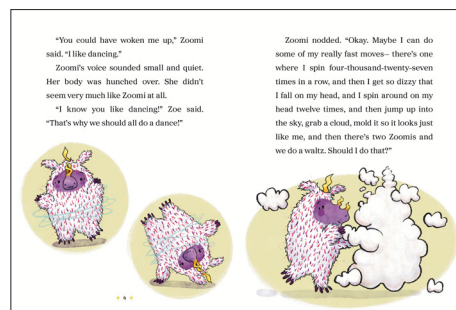

Subject:
Juvenile Fiction - Social Themes - Friendship
Juvenile Fiction - Social Themes - New Experience
Juvenile Fiction - Fantasy - Portals & Alternate Worlds

ISBN: 978-1-68369-462-5
\$15.99 USD
6 x 8, 96pp
4c, unjacketed hardcover
Ages 4-8

Rights sold: Audio (Dreamscape)
Translation: Available from Quirk
Film/ TV: Retained by Author (High Line Literary)

Publication Date: June 16, 2026
Final PDF Available: December 2025
ARC PDF Available: November 2025



A Spoonful of Time

By Flora Ahn

“Full of twists, this middle grade story is a heartwarming mix of food and family.”—Kirkus Reviews

When You Reach Me meets Love Sugar Magic in this unforgettable middle grade novel where time travel, family recipes, and family secrets collide.

Maya’s grandmother, Halmunee, may be losing her memory, but she hasn’t lost her magic touch in the kitchen. When she serves salty miyeok-guk or sweet songpyeon, her stories about Korea come to life for Maya.

Then one day, something extraordinary happens: one delicious bite transports Maya and Halmunee into one of Halmunee’s memories. Suddenly they’re in Seoul, and Halmunee is young.

This is just the first of many secrets Maya will uncover: that she and her grandmother can travel through time. As Maya eats her way through the past, her questions multiply—until a shocking discovery transforms everything she thought she knew about family, friendship, loss, and time itself.

Brimming with heart and interspersed with seven family recipes that readers can make themselves, this is a story to savor by rising Korean American author Flora Ahn.

A Brush with Magic

By Flora Ahn

“Fantastical elements are seamlessly woven into this engaging, entertaining story A universal coming-of-age tale becomes extraordinary through an encounter with Korean folk magic.” —Kirkus Reviews, ★ starred review

A heartfelt, magical middle grade adventure—inspired by Korean folklore and set in modern-day Seoul—about sisterhood and belonging, perfect for fans of Kelly Yang and Janae Marks.

It’s finally summer break, and twelve-year-old Yumi is headed to Korea with her older sister, Minji, for the very first time. She can’t wait to explore the city of Seoul together—but Minji has other plans. The moment they land, Minji ditches Yumi to hang out with their cousins, who are more fashionable, better at soccer, and all-around cooler than Yumi. Lost and alone, Yumi is stuck at home painting with her grandfather.

Everything changes when she finds an intriguing ink brush in a neighborhood art shop—and she accidentally summons a creature straight out of her grandfather’s retellings of Korean fairy tales. With a new friend by her side and an ink brush that has the power to bring anything she paints to life, Yumi feels unstoppable. From bustling street markets and ancient palaces to riding the subway, Yumi and her friend explore everything Seoul has to offer.

But as the consequences of this newfound power come home to roost, Yumi must find the strength to embrace who she is and speak up for herself—before she loses everything and everyone she loves.



FLORA AHN is an attorney by day and an author and illustrator by night. Her work includes a children’s chapter book series, *Pug Pals* (Scholastic), and an Audible Original, *The Golden Orchard*. Raised in California by her Korean immigrant parents, Ahn lives in Virginia with her two pugs and practices law in Washington, DC.

A Spoonful of Time

ISBN: 978-1-68369-318-5

\$16.99 USD

5½ x 8, 272 pages,
1c hardcover with jacket and spot illustrations

Word Count: Approx. 50,000 words

Age Range: 8–12 years

Publication Date: April 2023

Rights Sold: Korean (Hello Robin), Turkish (Timaş), Audio (Blackstone)

A Brush with Magic

ISBN: 978-1-68369-320-8

\$16.99 USD

5½ x 8, 288 pages,
1c hardcover with jacket and spot illustrations

Word Count: Approx. 50,000 words

Age Range: 8–12 years

Publication Date: October 2024

Rights Sold: Audio: (Dreamscape), Turkish (Timaş)



OVER
7,500
COPIES
SOLD

Hunters of the Lost City

By Kali Wallace

“Reminiscent in feel to Kelly Barnhill’s *The Girl Who Drank the Moon*, this lovely fantasy introduces a complicated, brave, and believable heroine. . . . An absolute delight.”
—*Kirkus Reviews*, starred review

Packed with shocking twists, frightening monsters, and dark magic, this is a page-turning fantasy adventure for middle-grade fans of Holly Black and Tamora Pierce.

Twelve-year-old Octavia grew up believing the town of Vittoria was the only one left in the world. The sole survivors of a deadly magical war and plague, the people of Vittoria know there’s no one alive outside the town walls—except the terrible monsters that prowl the forest.

But then the impossible happens: Octavia meets another girl beyond the walls, someone who isn’t Vittorian. Everything she’s ever believed is thrown into question, and there’s no going back.

In her quest for the truth, Octavia discovers a world full of lies, monsters, and magic. She’ll have to use every scrap of her skill, wits, and courage to uncover what’s real about Vittoria and the rest of the world.

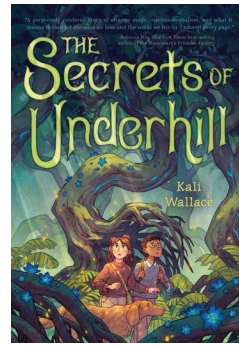

The Secrets of Underhill

By Kali Wallace

An eleven-year-old apprentice fights to save an ancient grove of magical trees that hold the key to her community’s survival in this page-turning fantasy adventure. Perfect for middle grade fans of Kelly Barnhill and Jessica Townsend.

Nick Sixsmith has spent her whole life on the road. The daughter of a traveling arborist, she moves with her mother from town to town, caring for the ironwood groves the communities rely upon. When a dangerous blight takes hold of these magical trees, they must journey to the city of Mistwood—her mother’s hometown—for answers.

Nick can’t wait to explore the prosperous city of Mistwood and all it has to offer: bustling markets and workshops, neighborhoods built under a roaring waterfall, and the vast ancestral grove of ironwood trees. But dark secrets simmer beneath the surface as people start to disappear and tensions rise in the city.

As the mystery grows, Nick and her new friends from Mistwood must follow the trail where it leads them: underground, to a strange, enchanting world called Underhill. Only there, among the roots of the ancestral grove, will Nick find a way to save her new home and the ironwood trees.

This immersive fantasy adventure combines vivid world-building with timely themes of environmentalism, and young readers will be riveted until the final page.



KALI WALLACE is the author of books for children and adults, including *City of Islands*, *Shallow Graves*, and *Salvation Day*. She lives in Portland, Oregon.

Hunters of the Lost City

ISBN: 978-1-68369-289-8

\$16.99 USD

5½ x 8, 304 pages
1c hardcover with jacket

Word Count: Approx. 70,000 words

Age Range: 10 and up

Publication Date:

April 2022

Rights Sold: Audio (Blackstone), Korean (Gravity Books)

The Secrets of Underhill

ISBN: 978-1-68369-388-8

\$17.99 USD

5½ x 8, 320 pages,
1c hardcover with jacket

Age Range: 10 and up

Word Count: Approx. 70,000 words

Publication Date:

January 2025

Rights Sold: All world rights available.

Nick and Tesla Series

When their parents send them to spend the summer with their eccentric uncle, twins Nick and Tesla Holt use science to solve mysteries and save the day. Each of their adventures features laugh-out-loud jokes, fun illustrations, and DIY science projects for readers to try at home.

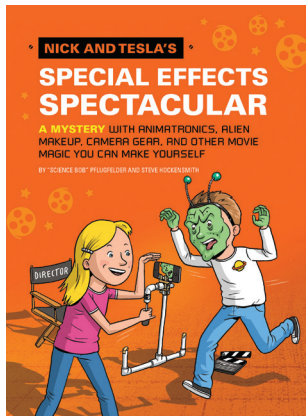
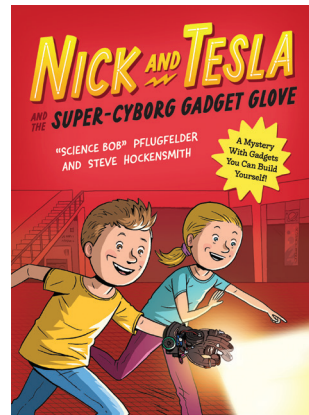
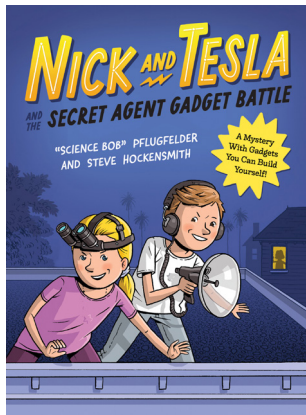
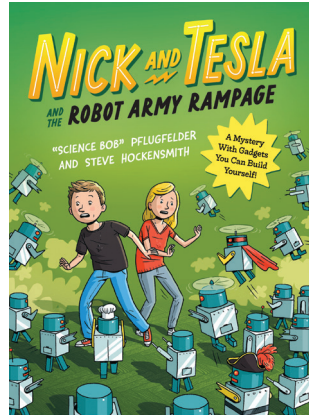
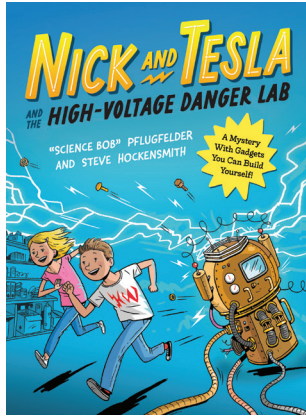

Active Rights Sold: Audio (Books 1 and 2 Only), Greek, Hungarian, Italian, Persian, Polish, Serbian, Turkish

Expired Rights Sold: Audio, Dramatic, Chinese (S), Czech, Indian English, Korean, Romanian

150,000 COPIES SOLD!

EACH BOOK INCLUDES FIVE DO-IT-YOURSELF SCIENCE PROJECTS DRAWN FROM THE STORY!

ISBN 978-1-68369-379-6 Nick and Tesla and the High-Voltage Danger Lab
 ISBN 978-1-68369-390-1 Nick and Tesla and the Robot Army Rampage
 ISBN 978-1-68369-403-8 Nick and Tesla and the Secret Agent Gadget Battle
 ISBN 978-1-68369-405-2 Nick and Tesla and the Super-Cyborg Gadget Glove
 ISBN 978-1-59474-760-1 Nick and Tesla's Special Effects Spectacular
 ISBN 978-1-59474-866-0 Nick and Tesla's Solar-Powered Showdown

\$8.99 USD
 5½ x 7½, 224–288 pages, 1c paperback
 Age Range: 8–12 years
 Approx. 40 illustrations and 40,000 words

“SCIENCE BOB” PFLUGFELDER is a teacher who loves building fun gadgets that he shares on television and online.

STEVE HOCKENSMITH is a *New York Times* best-selling author and mystery writer.

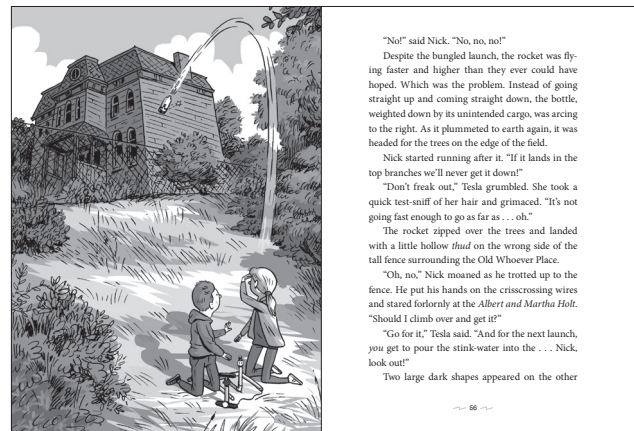
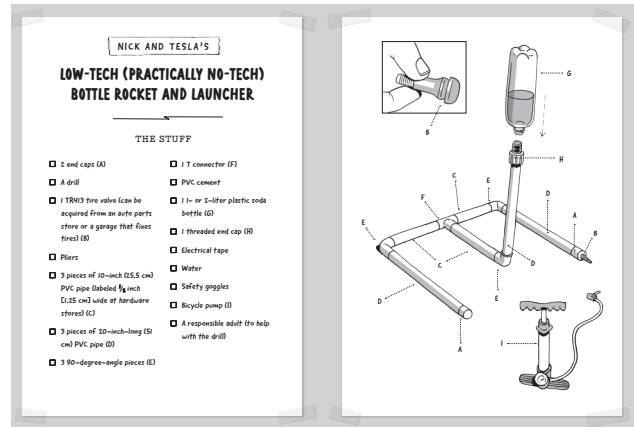

Warren the 13th Series

A strange-looking kid with a heart of gold, fastidious orphan Warren has one dream: to restore his family's creepy old hotel to its former glory. But to do that, he has to contend with mysterious visitors, secret codes, hidden maps, weird creatures, and angry witches. Luckily Warren has friends to help him, including a witch-in-training, a circus strongman turned chef, a reclusive professor, and a friendly monster named Sketchy.

“An engaging mystery to unravel, with a few nice twists and surprises along the way.”

—*New York Times Book Review*

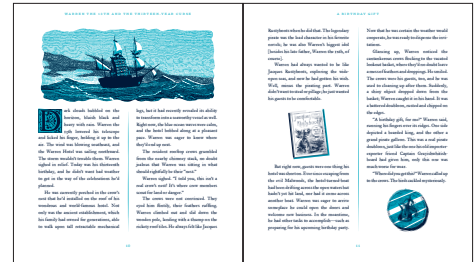
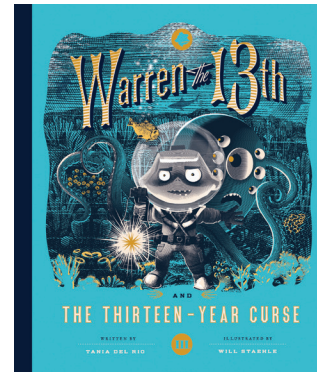

Warren the 13th and the All-Seeing Eye

A beautifully illustrated, action-packed middle grade adventure in the spirit of Edward Gorey and Lemny Snicket.

Warren the 13th is the lone bellhop, valet, groundskeeper, and errand boy of his family's ancient hotel. The strange, shadowy mansion is full of crooked corridors and mysterious riddles—and it just might be home to a magical treasure known as the All-Seeing Eye. But if Warren is going to find the hidden treasure, he'll need to solve several other mysteries first: What is the strange creature lurking in the hotel boiler room? Who is the ghostly girl creeping around the garden's hedge maze? And why is the hotel's only guest covered in bandages?

Publication Date: November 2015
ISBN 978-1-59474-803-5
\$16.95 USD
 7½ x 8½, 224 pages,
 2c unjacketed hardcover
Age Range: 10 and up
Rights Sold: Audio, Basque, Bulgarian (Expired), Catalan, Chinese-S, Czech, Estonian (Expired), Finnish, French (Expired), German (Expired), Greek, Hungarian (Expired), Italian, Korean (Expired), Lithuanian (Expired), Persian (Expired), Polish (Expired), Portuguese in Brazil (Expired), Romanian, Russian (Expired), Serbian (Expired), Slovak (Expired), Spanish in Europe, Spanish in LatAm, Thai, Turkish (Expired)

Warren the 13th and the Whispering Woods

Twelve-year-old Warren has learned that his beloved hotel can walk, and now it's ferrying guests around the countryside, transporting tourists to strange and foreign destinations. But when an unexpected detour brings everyone into the dark and sinister Malwoods, Warren finds himself separated from his hotel and his friends—and racing after them on foot through a forest teeming with witches, snakes, talking trees, and mind-boggling riddles.

Publication Date: March 2017
ISBN 978-1-59474-929-2
\$16.95 USD
 7½ x 8½, 240 pages,
 2c unjacketed hardcover
Age Range: 10 and up
Rights Sold: Audio (Expired), Dramatic (Expired), Basque, Bulgarian (Expired), Catalan, Chinese-S, Czech (Expired), Estonian, Finnish, French (Expired), Greek, Hungarian, Korean (Expired), Persian, Romanian, Russian, Slovak (Expired), Spanish in Europe, Spanish in LatAm (Expired), Thai

Warren the 13th and the 13-Year Curse

In this final story of Warren's thrilling adventures, the young manager is adjusting to the demands of running a floating hotel and is planning his thirteenth birthday party. But then disaster strikes! The Warren Hotel is shipwrecked on a strange island, and Sketchy is kidnapped! Warren and his crew of friends set off on a daring rescue mission across the high seas where they meet a delightful new cast of characters that includes wizened pirates, a sea witch, and a talking clam. As Warren pursues his many-tentacled friend's kidnappers, he will learn the truth of Sketchy's mysterious origins—as well as one final secret of his beloved Warren Hotel.

Publication Date: March 2020
ISBN 978-1-68369-090-0
\$16.99 USD
 7½ x 8½, 224 pages,
 2c unjacketed hardcover
Age Range: 10 and up
Rights Sold: Basque, Bulgarian, Catalan, Chinese-S, Czech, Finnish, Hungarian, Persian (Expired), Russian, Slovak (Expired), Spanish in Europe, Spanish in LatAm, Thai



TANIA DEL RIO is the author of the Warren the 13th series. A professional comic book writer and artist, her clients include Archie Comics, Dark Horse, and Marvel.



WILL STAEHLE is the illustrator and designer of the Warren the 13th series, plus dozens of award-winning book jackets.

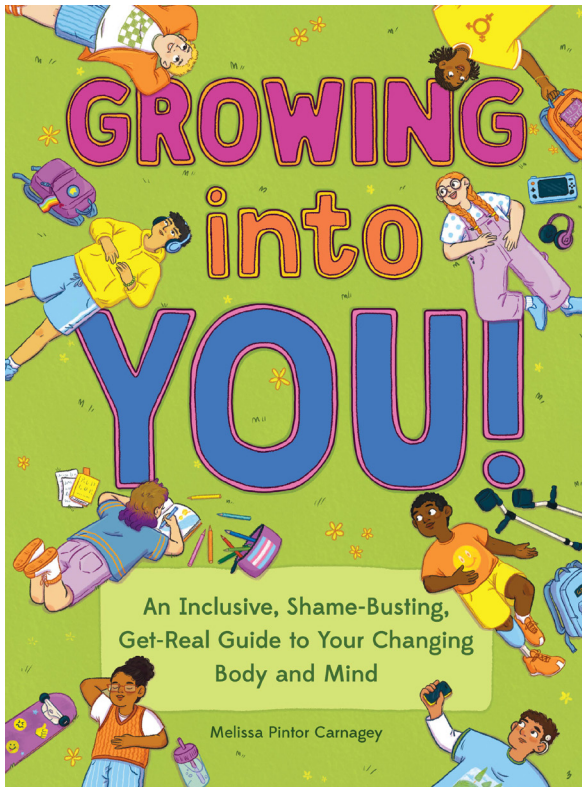

Growing into You!

An Inclusive, Shame-Busting, Get-Real Guide to Your Changing Body and Mind

By Melissa Pintor Carnagey; Illustrated by Brianna Gilmartin

For tweens of all gender identities ages 10 to 14 and their trusted caregivers, *Growing into You!* is a shame-busting, interactive guide to puberty and changing bodies by the founder of Sex Positive Families.

Body hair. Changing friendships. Weird fluids. The tween years can be awkward and confusing—but with enough information and an open mind, you can thrive!

Growing Into You! has all the facts you're looking for and more. For example, did you know that . . .

- Voice changes happen to people of all genders?
- Breast buds aren't just something girls develop?
- Sleep actually helps your body grow bones and muscles?
- Everyone has their own unique relationship to gender?

By the founder of Sex Positive Families, a groundbreaking education platform dedicated to shame-free, inclusive conversations around bodies and sexuality, *Growing Into You!* is a modern primer on the puberty years for Generation Alpha.

Packed with essential information, surprising facts, fun activities, conversation starters, and more, you'll find plenty to take into the real world with you. After all, growing into you is a journey—so it's time to embrace curiosity, ask questions, and treat your body with respect and care!



MELISSA PINTOR CARNAGEY, LBSW (she/they) is a Black, Puerto Rican, and Mexican sexuality educator and licensed social worker who believes that all children deserve holistic, comprehensive, and shame-free sexuality education. Her professional experience spans 15 years in the field of sexual health. She is the creator of the Growing Into You!™ virtual puberty education program, and is based out of Austin, Texas.

BRIANNA GILMARTIN enjoys creating work that is full of silly and imaginative fun and reflective of quieter moments of life, as well as more emotional work that studies the human condition, human emotions, and our need for human connection.

This valuable resource for families aims to change the conversation around puberty, from a trailblazer in sexual health education and the founder of the popular Sex Positive Families online platform.



Subject:
 Juvenile Nonfiction - Health & Daily Living - Maturing
 Juvenile Nonfiction - Social Topics - New Experience
 Juvenile Nonfiction - Science & Nature - Anatomy & Physiology

ISBN: 978-1-68369-431-1
 \$17.99 USD
 6 1/2 x 8 3/4, 176 pages
 4c paperback
Age Range: 10-14

Rights:
Translation: German (Zuckersüß Verlag)
Audio: Penguin Random House
Film/TV: Retained by author

Publication Date: May 2025
Final PDF Available: Now

The Worst-Case Scenario Survival Handbook For Kids

By David Borgenicht and Justin Heimberg
Illustrated by Wenke Kramp

Erupting volcanoes. Ravenous sharks. Pooping in the woods.

The great outdoors is a weird, wonderful, and scare-your-pants-off terrifying place. Whether you're freezing in the Arctic, escaping quicksand in the jungle, or befriending tarantulas in the desert, this guide has you covered. (Figuratively, not literally. We didn't have the budget for a blanket-sized book.)

Bust this guide open and discover step-by-step instructions for surviving the most extreme situations that Planet Earth can throw at you. Learn how to:

- Dodge a charging rhinoceros
- Ride out a sandstorm
- Navigate by the stars
- Build a snow cave
- Cross piranha-infested waters
- And much more!

Yeah, the outdoors can be scary, but you've got this indispensable, laugh-out-loud survival guide. So what are you waiting for? Get out there!



DAVE BORGENICHT, is the coauthor of all the books in the Worst-Case Scenario Survival Handbook series and the founder of Quirk Books. He knows how to float on quicksand, jump from a moving car, and properly groom a gorilla. He lives in Philadelphia.

JUSTIN HEIMBERG defines the word extreme. He is extremely cautious and wary. He is an extreme sleeper and an extreme television watcher. On the rare occasion when Justin is not being extreme, he writes books and films. He lives in an extreme suburb in Maryland.



WENKE KRAMP is an illustrator from Berlin, Germany.

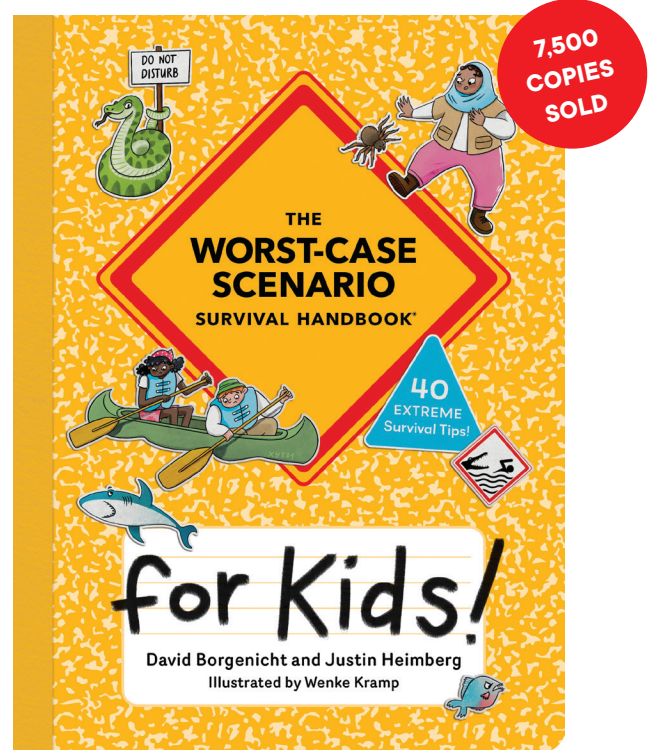

A 2024 NATIONAL PARENTING PRODUCT AWARDS WINNER

The best-selling (and wildly hilarious) Worst-Case Scenario series is back with 40 extreme survival tips for kids ages 8 to 12, great for adventurous fans of the I Survived series.

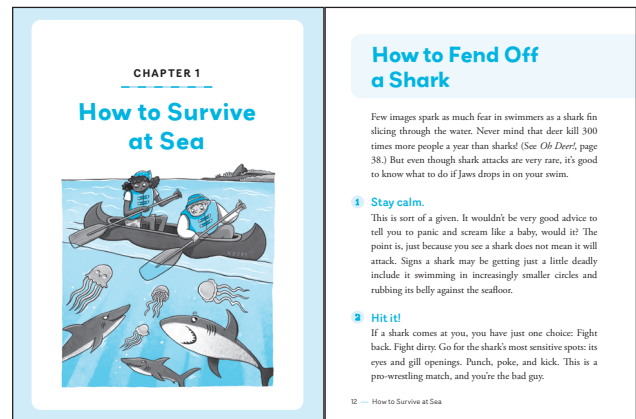

Subject:
Juvenile Nonfiction - Adventure & Adventurers
Juvenile Nonfiction - Science & Nature - Disasters
Juvenile Nonfiction - Humor

ISBN: 978-1-68369-456-4
\$12.99 USD
6 x 8, 128 pages
2c paperback with spot illustrations throughout
Age Range: 8-12

Rights:
Translation: Korean (GrassAndWind Publishing)
Audiobook: Available from Quirk
Film/TV: Available from Quirk

Publication Date: September 2024

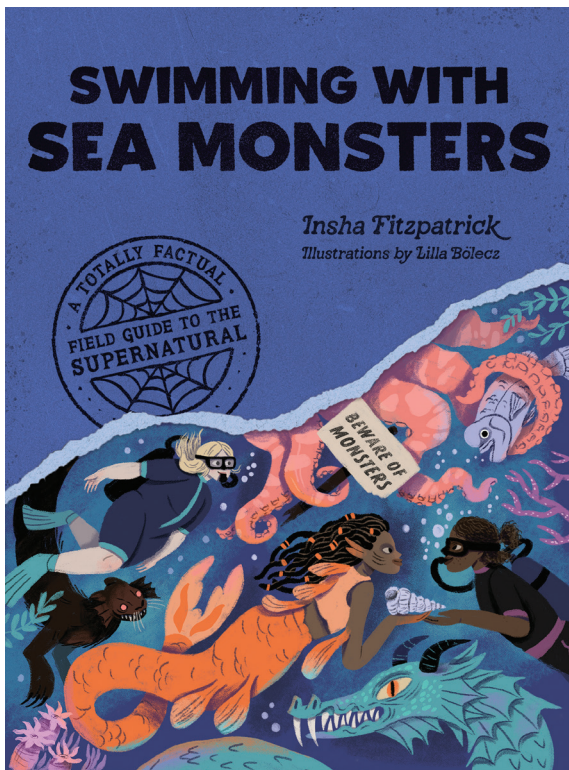

Swimming with Sea Monsters
 A Totally Factual Field Guide to the Supernatural
 By Insha Fitzpatrick, illustrated by Lilla Bölec

Set sail for adventure with this illustrated guide to sea monsters and the ocean, featuring cool science, fascinating history, and hands-on activities—perfect for readers age 8-12!

The fourth book in the Totally Factual Field Guide to the Supernatural series, *Swimming with Sea Monsters* is a funny and informative non-fiction guide to how myths and legends are shaped by the world around us.

Ahoy there! Ever wonder how deep the ocean is? Curious about what sea creatures—real and legendary—swim beneath the waves? Want to know how we can protect the coral reefs? Dive into *Swimming with Sea Monsters* and discover:

- **Fascinating science and fun facts about the ocean!** Descend to the depths of the ocean and meet creatures like the colossal squid and the anglerfish.
- **Eye-opening history and ancient mythology!** Get to know the sea monsters in *The Odyssey* and pirate queen Zheng Yi Sao.
- **Nautical fiction and enchanting fairy tales!** Read up on legends of sea monsters from around the world and the classic fairy tale *The Little Mermaid*.

Learn all about the ocean and sea monsters with charming illustrations and hands-on activities you can try at home, like creating a zine about ocean conservation and building a beach terrarium! The whole world is out there—grab your guide, and let's go!

For more fun and educational field guides, check out *Hanging with Vampires*, *Chilling with Ghosts*, and *Sightseeing with Aliens!*

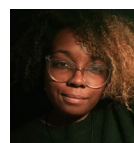
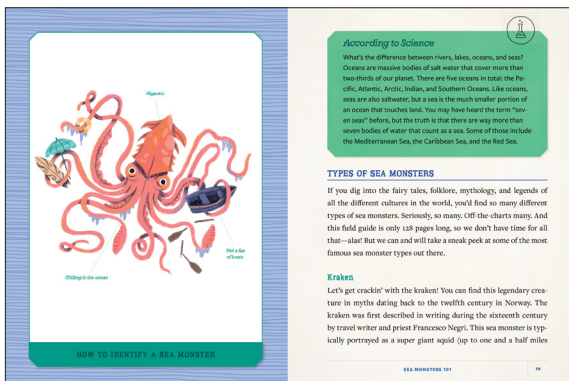
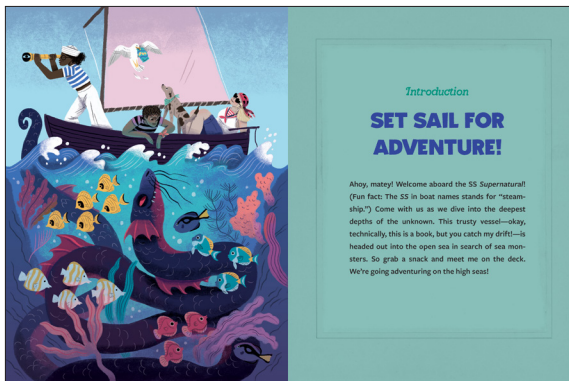

INSHA FITZPATRICK is a New Jersey-based author who loves all things horror. She's the writer of *Who Sparked the Montgomery Bus Boycott: Rosa Parks (Who HQ)*, illustrated by Abelle Hayford. She's also the coauthor of the middle grade graphic novel series *Oh My Gods!* with Stephanie Cooke and illustrator Juliana Moon. When she's not writing, she's watching horror movies or reality TV and deep-diving into all things true crime.

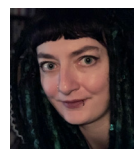

LILLA BÖLECZ is a Hungarian graphic artist and illustrator whose passion is creating peculiar, thought-provoking, and mystical scenes and characters inspired by, among other things, nature and mythology.

Subject:
 Juvenile Nonfiction - Paranormal & Supernatural
 Juvenile Nonfiction - History - General
 Juvenile Nonfiction - Social Science - Folklore & Mythology

ISBN: 978-1-68369-435-9
ISBN-13: 978-1-68369-435-9
 \$14.99 USD
 6 x 8, 128 pages,
 4c paperback with flaps
Word Count: Approx 10,000 words
Age Range: 8-12 years

Rights Sold:
 All world rights available.

Publication Date: April 6, 2027
ARC PDF Available: Now

ABOUT THE SERIES

A funny and informative nonfiction series for curious readers. A *Totally Factual Field Guide to the Supernatural* explores the supernatural, extraterrestrial, and paranormal with a field guide approach to our world's myths and legends. Engrossing science and fascinating history come to life with charming illustrations, kid-friendly text, and educational hands-on activities.

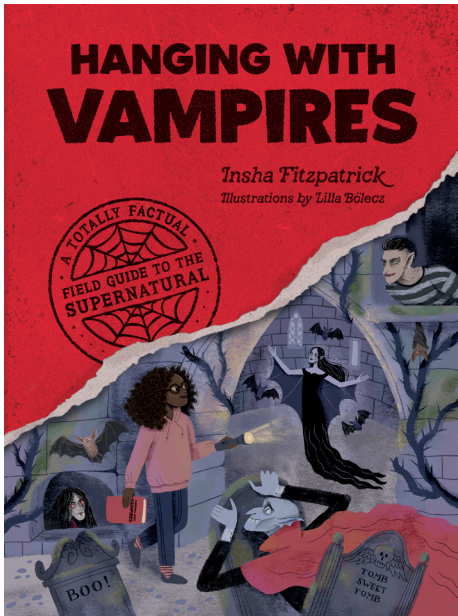
**Hanging with Vampires**

A *Totally Factual Field Guide to the Supernatural*

By Insha Fitzpatrick, illustrated by Lilla Bölec

Are vampires real? Who was Vlad the Impaler? Do vampire bats ever feed on humans? Find out in *Hanging with Vampires*, a field guide for the curious and the adventurous. Crack open the lid on this guide and you'll get:

- Bloodcurdling vampire mythology! What exactly is a vampire, anyway?
- Spine-chilling history and science! Uncover how the vampire legend got its start in the medieval ages.
- A who's who of vampires! Get to know classic, iconic, and terrifying vampires in pop culture, from *Dracula* to *Adventure Time*.

ISBN: 978-1-68369-341-3

Price: \$14.99 USD

Publication Date: March 2023

Rights Sold: Italian (Moscabianca), World Spanish (Siruela)

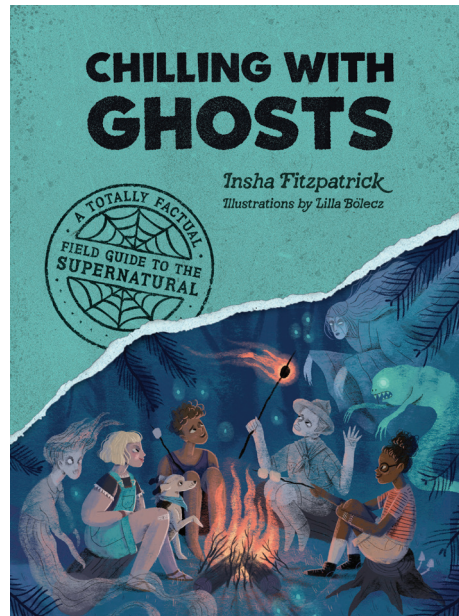
**Chilling with Ghosts**

A *Totally Factual Field Guide to the Supernatural*

By Insha Fitzpatrick, illustrated by Lilla Bölec

Boo! Do you believe in ghosts? What's up with haunted houses? And how exactly do you bust a ghost? Uncover the spooky and spectral world of ghosts in *Chilling with Ghosts*, a field guide for the curious and the adventurous. Step into the unknown—if you dare!—and discover:

- Haunting history and super weird science! Meet ghosts from ancient mythology and find out what exactly ghost fungus is.
- Scary ghost stories of all kinds! Meet the ghost of the renowned playwright William Shakespeare and craft your very own ghost story.
- A globe-trotting tour of haunted spots! Travel all around the world, from the Catacombs of Paris to the Winchester Mystery House.

ISBN: 978-1-68369-345-1

Price: \$14.99 USD

Publication Date: August 2023

Rights Sold: Italian (Moscabianca)

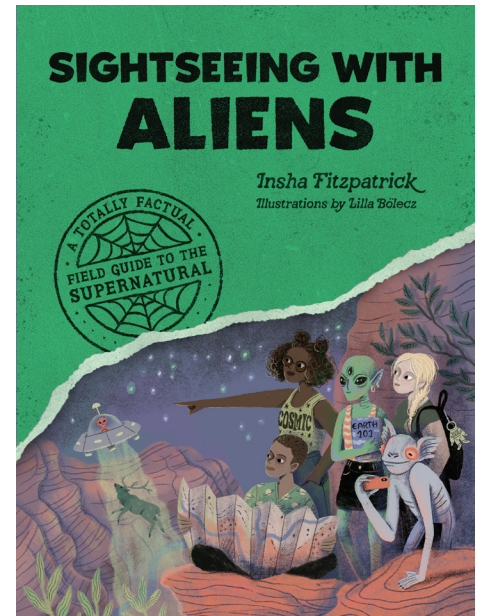
**Sightseeing with Aliens**

A *Totally Factual Field Guide to the Supernatural*

By Insha Fitzpatrick, illustrated by Lilla Bölec

Are aliens out there? What's the deal with Area 51? Can outer space support human life? Blast off to space with *Sightseeing with Aliens* and discover:

- Cool science and eye-opening history! Learn about the past, present, and future of space exploration.
- Strange accounts of alien encounters! Dig into the truth behind UFO sightings, crop circles, extraterrestrial events, and more.
- Hands-on activities to try at home! Create a time capsule and learn how to advocate for the environment.

ISBN: 978-1-68369-427-4

Price: \$14.99 USD

Publication Date: August 2024

Rights Sold: All world rights available.



Featuring kid-friendly text and full-color illustrations, readers ages 8–12 will be inspired to dream bigger, faster, and higher than ever before!



Kid Olympians: Winter

By Robin Stevenson
Illustrated by Allison Steinfeld

Triumphant, relatable, and totally true biographies tell the childhood stories of a diverse group of international athletes who have captured the world’s attention at the Winter Olympics and Paralympics, including Johnny Weir, Chloe Kim, Alex and Maia Shibutani, Surya Bonaly, and 13 other inspiring Olympians.

All over the world, athletes break records and defy odds to compete in the games—and they were kids themselves when they started dreaming and training! In *Kid Olympians: Winter*, discover the childhood stories of legends such as:

- **Michelle Kwan**, who used to sleep in her skating clothes to get a few extra minutes of sleep before her lessons at dawn!
- **Cindy Ouellet**, one of the few athletes to have competed in both the Winter and Summer Paralympics.
- **Apolo Ohno**, who started skating because he thought speed skaters looked like superheroes!

The diverse and inspiring group also includes Callan Chythlook-Sifsof, Adam Rippon, Kristi Yamaguchi, Lindsey Vonn, Marie-Philip Poulin, Shani Davis, Charles and William Flaherty, Maame Biney, and Nathan Chen.



ROBIN STEVENSON is an award-winning author of more than twenty books for kids and teens. Her writing has been translated into a number of languages, published in more than ten countries, and nominated for many awards. Her YA novel, *A Thousand Shades of Blue*, was a finalist for Canada’s top literary honor, the Governor General’s Award. Her YA nonfiction book, *Pride*, was a Stonewall Honor book and was selected to ALA’s Rainbow List. She lives with her family on the west coast of Canada.



ALLISON STEINFELD obtained a BFA from the School of Visual Arts in New York City. She loves to create fun and playful work that can be enjoyed by readers of all ages. She lives in Atlanta, Georgia.

Subject:
Juvenile Nonfiction - Sports & Recreation - Olympics & Paralympics

Juvenile Nonfiction - Biography & Autobiography - Sports & Recreation

Juvenile Nonfiction - Biography & Autobiography - Social Activists

ISBN: 978-1-68369-393-2

\$14.99 USD

5½ x 8, 240 pages,
4c unjacketed hardcover

Age Range: 8–12

Word count: Approx. 25,000 words

Illustrations: Approx. 200 4c illustrations.

Rights Sold: Audio (Dreamscape)

Publication Date: November 11, 2025

Final PDF Available: Now



Kid Legends Series

Before they were famous, they were kids, struggling with regular-kid problems like bullies, homework, and arguments with their siblings. Inspiring anecdotes and playful illustrations reveal the relatable childhood escapades of celebrated presidents, great athletes, groundbreaking scientists, and other future legends.

IN TEN LANGUAGES WORLDWIDE!

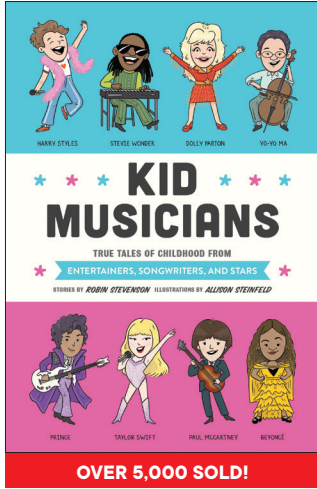

Kid Musicians
 ISBN 978-1-68369-391-8
 5½ x 8, 224 pages, 4c hardcover
Publication Date: January 2024
Rights sold: Audio, Serbian, Spanish, Vietnamese



Kid Olympians: Summer
 ISBN 978-1-68369-371-0
 5½ x 8, 240 pages, 4c hardcover
Publication Date: January 2024
Rights sold: Audio, Vietnamese



Kid Trailblazers
 ISBN 978-1-68369-301-7
 \$14.99 USD
 5½ x 8, 224 pages, 4c hardcover
Publication Date: August 2022
Rights sold: Audio, Vietnamese



Kid Innovators
 ISBN 978-1-68369-227-0
 \$14.99 USD
 5½ x 8, 208 pages, 4c hardcover
Publication Date: February 2021

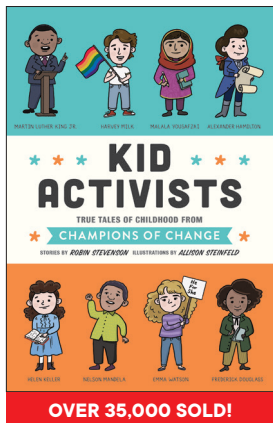

Kid Activists
 ISBN 978-1-68639-141-9
 5½ x 8, 224 pages, 4c hardcover
Publication Date: September 2019
Rights sold: Audio, Spanish

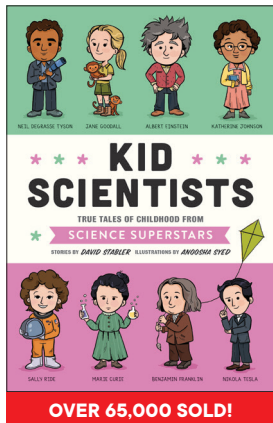

Kid Scientists
 ISBN 978-1-68639-074-0
 5½ x 8, 208 pages, 4c hardcover
Publication Date: October 2018
Rights sold: Audio, Chinese-S, Greek, Korean (Expired), Russian (Sold), Turkish, Vietnamese

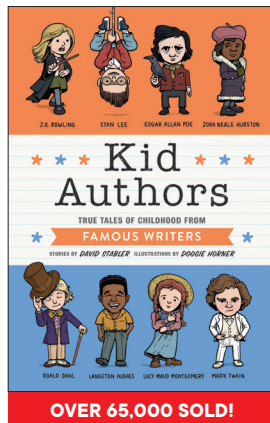

Kid Authors
 ISBN 978-1-59474-987-2
 5½ x 8, 200 pages, 4c hardcover
Publication Date: October 2017
Rights sold: Audio, Chinese-S, Hebrew, Turkish, Vietnamese

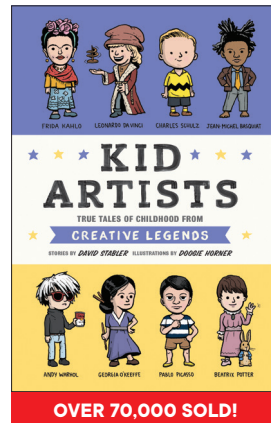

Kid Artists
 ISBN 978-1-59474-896-7
 5½ x 8, 208 pages, 4c hardcover
Publication Date: August 2016
Rights sold: Audio, Chinese-S, Greek (Expired), Hebrew, Korean (Expired), Spanish, Turkish, Vietnamese

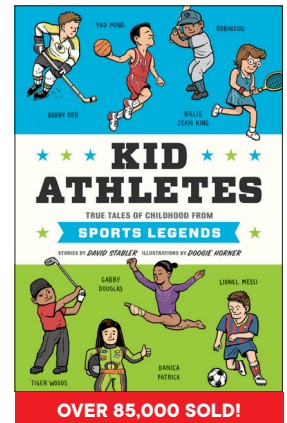

Kid Athletes
 ISBN 978-1-59474-802-8
 5½ x 8, 224 pages, 4c hardcover
Publication Date: November 2015
Rights sold: Audio, Chinese-S (Expired), Greek, Russian (Expired), Turkish, Vietnamese

Little Kid, Big City!

Kids pick their own path through the most exciting cities in the world in *Little Kid, Big City!* With fun and little-known facts about locations, a resource section of useful information, prompts to choose which way to travel next, and a foldout map of each city, this series will delight kids on the move or those who want to learn about far-flung locales from home.



Little Kid, Big City!: New York

By Beth Beckman; illustrated by Holly Maher

If you could have an adventure in New York City, where would you go?

Would you walk the Brooklyn Bridge for a huge slice of pizza, see the dazzling lights in Times Square, or visit the whale at the Museum of Natural History?

Create your own itinerary, choose which places to visit at the end of every page, and follow along with an adventurous family as they explore New York.

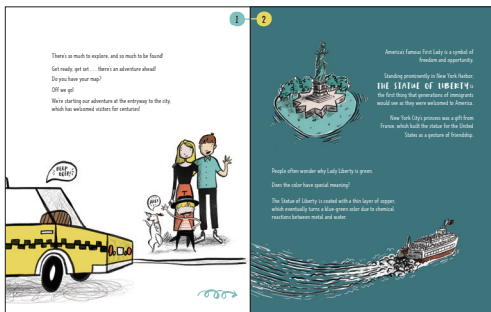

Little Kid, Big City!: London

By Beth Beckman; illustrated by Holly Maher

If you could have an adventure in London, where would you go?

Would you hop on the Tube to visit Buckingham Palace, find a tasty lunch on Brick Lane, or pass the time with Big Ben?

Create your own itinerary, choose which places to visit at the end of every page, and follow along with an adventurous girl and her two moms as they explore London.



BETH BECKMAN is the editor and founder of the namesake website, Little Kid, Big City, and is trusted by parents across the country as an authority on traveling with kiddos.



HOLLEY MAHER is the celebrated stationery designer behind Wink Wink Paper Co, as well as a songwriter and recording artist. She lives in Nashville, Tennessee, with a lazy dog named Booker. You can find her online at holleymaher.com.

Little Kid, Big City!: New York

ISBN 978-1-68369-244-7

\$19.99 USD

8 x 10, 88 pages
4c unjacketed hardcover with fold-out poster

Age Range: 8-12

Rights Sold: Galician (Bululú), Spanish (Bululú)

Publication Date: February 2021

Little Kid, Big City!: London

ISBN: 978-1-68369-248-5

\$19.99 USD

8 x 10, 88 pages
4c unjacketed hardcover with fold-out poster

Age Range: 8-12

Rights Sold: Galician (Bululú), Spanish (Bululú)

Publication Date: June 2021



Pet That Dog!

By Gideon Kidd and Rachel Braunigan, illustrated by Susann Hoffmann

A guide for young readers to befriend and care for dogs of all shapes, sizes, and personalities. This kid-friendly handbook pairs joyful illustrations with an interactive format. With step-by-step guides, fascinating stories, and helpful tips, *Pet That Dog!* makes a perfect gift for dog-curious kids and dog lovers of all ages.

ISBN 978-1-68369-229-4
\$14.99 USD
6 x 8, 128 pages
4c paperback
Age Range: 7 and up
Rights Sold: Hungarian (Kossuth)
Publication Date: October 2020



Pet That Cat!

By Nigel Kidd and Rachel Braunigan, illustrated by Susann Hoffmann

A fun and informative handbook for young readers on understanding and caring for our feline friends. This kid-friendly handbook pairs charming illustrations with an interactive format. With step-by-step guides, fascinating stories, and tips from cat experts and Nigel, *Pet That Cat!* is a must-have handbook for feline fans of all ages.

ISBN 978-1-68369-314-7
\$14.99 USD
6 x 8, 128 pages
4c paperback
Age Range: 7 and up
Rights Sold: Czech (Albatros)
Publication Date: July 2022

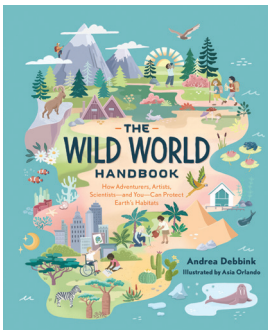

The Wild World Handbook: Habitats

By Andrea Debbink, illustrated by Asia Orlando

Packed with real-life tales of adventure, breathtaking illustrations, and hands-on STEAM activities, this handbook is an inspiring guide for the next generation of climate activists, conservationists, and nature lovers.

The first book in a middle grade series for young environmental activists and nature lovers, *The Wild World Handbook: Habitats* offers a roadmap for change and an invitation to explore the outdoors, alongside surprising facts and hands-on STEAM activities. Featuring nine habitats from around the globe, each section includes diverse biographies of outdoor adventurers, scientists, and artists who used their passion and skills to become bold allies for Earth's natural diversity and resiliency.

ISBN 978-1-68369-246-1
\$19.99 USD
6 1/4 x 8 1/2, 232 pages
4c paperback
Age Range: 8-12
Rights Sold: Serbian (Blum/Kalipso)
Publication Date: May 2021

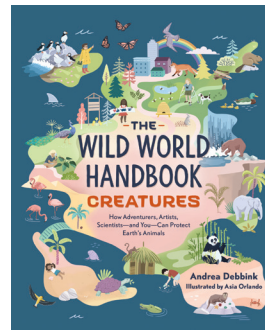

The Wild World Handbook: Creatures

By Andrea Debbink, illustrated by Asia Orlando

We share this incredible planet we call home with countless living creatures, from butterflies and falcons to koalas and dolphins. And just like us, animals everywhere are faced with the growing threat of climate change.

Featuring seven categories of creatures, this handbook offers a roadmap for change and an invitation to explore the outdoors with fascinating facts, hope-filled stories, and hands-on STEAM activities. Each chapter highlights the biographies of scientists, artists, and adventurers from diverse backgrounds who have used their passion and skills to become courageous advocates for animals around the world.

ISBN 978-1-68369-268-3
\$19.99 USD
6 1/4 x 8 1/2, 192 pages
4c paperback
Age Range: 8-12
Rights Sold: Serbian (Blum/Kalipso)
Publication Date: November 2021

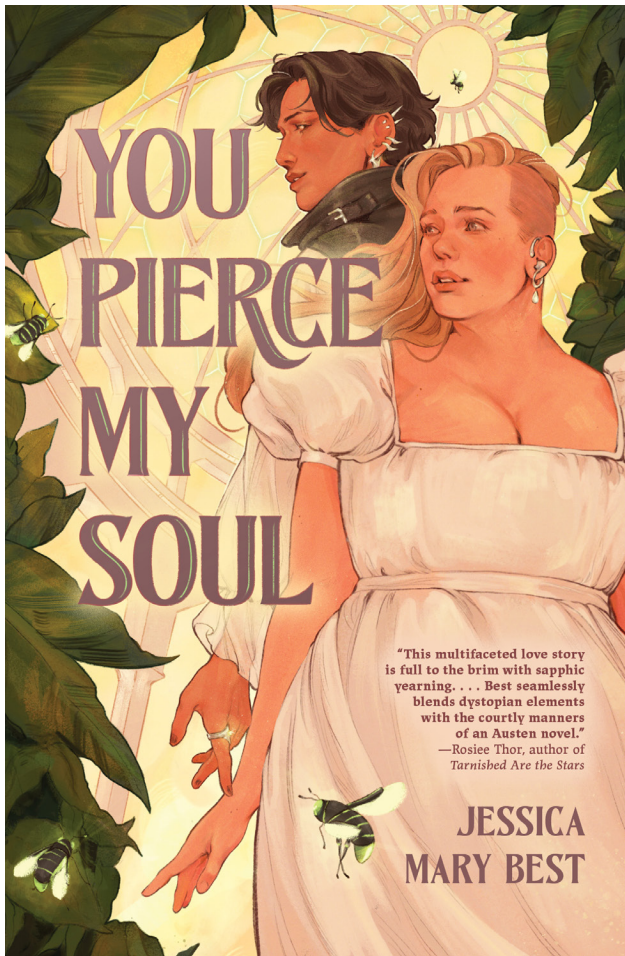

You Pierce My Soul

By Jessica Mary Best

In the utopian city of New Ionia, everyone gets a soulmate—and Zada can't wait for hers. Now that she's eighteen, it's her turn to meet her destiny with the help of Heartsong, an algorithm that chooses your perfect match for you.

Then Zada crashes into her soulmate, setting off their shared Heartsong, and the unthinkable happens: She feels nothing for him. But the Heartsong program doesn't make mistakes, and by the end of the night, Zada is engaged to a man she doesn't love.

Desperate for a way out, Zada turns to her beautiful, reckless, and utterly impossible former best friend Daphne. Together, the two embark on a quest for the truth that throws Heartsong—and their entire world—into question. As time runs out, Zada must find the courage to choose what she believes and who she loves.



JESSICA MARY BEST is a multi-award-winning freelance writer/editor, an amateur singer/songwriter and a well-intentioned ball of pure quivering anxiety. She is based out of the Midwest.

Packed with shocking plot twists and sapphic yearning, this romantic and thrilling dystopian YA is perfect for fans of Rachael Lippincott.

“Snappy banter and heartfelt romance, wrapped in the sleek mystery of a *Black Mirror* episode. Absolutely delicious!”

—Natalie Naudus, award-winning audiobook narrator and author of *Gay the Pray Away*

“This multifaceted love story is full to the brim with sapphic yearning, clever banter, and inventive world-building. Jessica Mary Best seamlessly blends dystopian elements with the courtly manners of an Austen novel. *You Pierce My Soul* is a must-read for fans of Catherine Bakewell and Malinda Lo.”

—Rosiee Thor, author of *Tarnished Are the Stars*

Subjects:

Young Adult Fiction - Romance - LGBTQ+
 Young Adult Fiction - Dystopian
 Young Adult Fiction - Science Fiction - Romance

ISBN: 978-1-68369-500-4

\$12.99 USD
 5¼ x 8, 320pp
 Word count: approx. 75,000
 Ages 14 and up

Rights:

Audio and translation rights available
 Film/TV retained by author (Dystel, Goderich & Bourret LLC)

Publication Date: May 5, 2026

Final PDF Available: Now

Gay the Pray Away

By Natalie Naudus

“Achingly heartfelt and resoundingly beautiful. I need more books from Natalie Naudus ASAP!”

—Julie Abe, author of *The Charmed List* and *Our Cursed Love*

Valerie Danners is in a cult. She just doesn’t know it yet. But when she stumbles upon a queer romance novel at the library, everything about her life—centered around a conservative Christian homeschool cult—is thrown into question.

And to make things even more complicated, there’s a new girl in town. Riley is rebellious, kindhearted, and impossibly cool. As the two bond over being multiracial teens in their very white and very religious community, Valerie finds herself falling in love.

Soon Valerie and Riley are exchanging notes in secret and stealing kisses behind the church. But even as their romance blooms, Valerie knows that they’re trapped. If Valerie wants a chance at writing her own story, she must choose between staying with a family she fears will never accept her or running away with the girl she loves.



NATALIE NAUDUS is one of the most beloved audiobook narrators working today. She has won an Audie award and nine Earphones awards and maintains a robust social media following. She lives with her family on a mountain in Virginia.



“Composed with equal parts sweetness, care, and stubborn queer perseverance.”

—**CASEY McQUISTON**, #1 *New York Times* best-selling author of *Red, White & Royal Blue*

In this gripping queer YA romance perfect for fans of Malinda Lo and Becky Albertalli, an Asian American teen longs to break free of the conservative cult she was raised in.

<p>Subject: Young Adult Fiction - Coming Of Age Young Adult Fiction - Romance - LGBTQ+ Young Adult Fiction - Asian American & Pacific Islander</p>	<p>ISBN 978-1-68369-511-0 \$12.99 USD 5¼ x 8, 256 pages, Trade Paperback Age Range: 14 and up</p>	<p>Rights: All translation rights available. Film & audio reserved to author.</p>	<p>Publication Date: May 2025 Final PDF Available: Now</p>
---	--	--	--

Miss Peregrine's Peculiar Children Series

Published by Quirk Books in 2011, *Miss Peregrine's Home for Peculiar Children* follows sixteen-year-old Jacob Portman as he journeys from a sleepy Florida suburb to a remote island off the coast of Wales. There he stumbles upon the ruins of Miss Peregrine's orphanage and discovers the shocking fate of the children who lived there long ago—and may live there still.

Miss Peregrine's Home for Peculiar Children was followed by two best-selling sequels, *Hollow City* and *Library of Souls*. All three novels are illustrated with dozens of vintage found photographs.

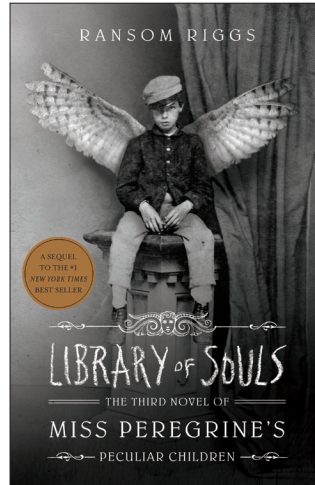
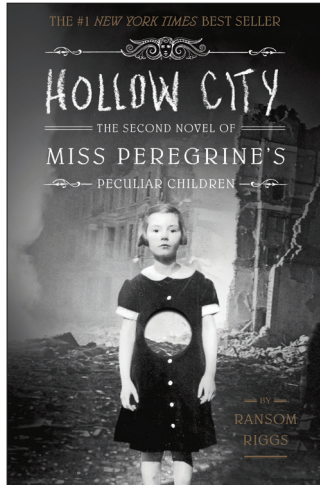
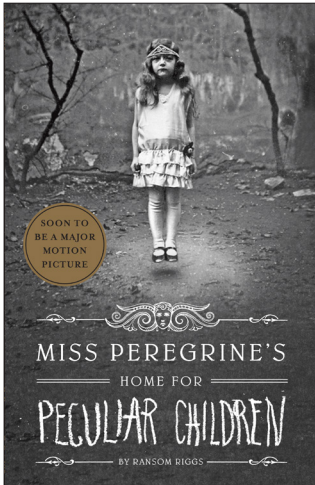

SAMPLE SPREADS

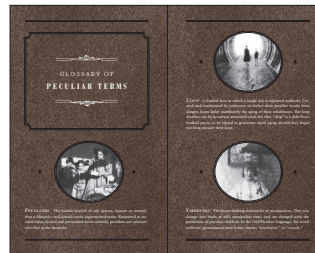
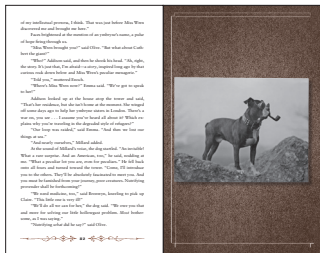
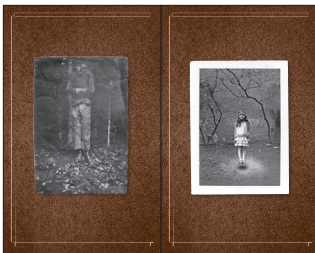

Rights:

Audio: PRH Audio (Volume 1), Blackstone (Volumes 2 and 3)

Film/TV: A major motion picture from 20th Century Studios, directed by Tim Burton

Translation:

Active: Albanian (Pegi), Armenian (Arevik), Catalan (L'Altra), Simp. Chinese (Huaxia Winshare), Trad. Chinese (Global Group), Croatian (Lumen), Czech (Jota), Dutch (Clavis), French (Bayard), German (Droemer), Italian (Rizzoli), Korean (Hyundaemunhak), Lithuanian (Alma Littera), Polish (Media Rodzina), Brazilian Portuguese (Intrinseca), Romanian (ART), Sinhalese (Favorite), Spanish (Planeta), Swedish (Rabén & Sjögren), Turkish (Ithaki), Vietnamese (Nha Nam)

EXPIRED & AVAILABLE FROM QUIRK: Azerbaijani (TEAS), Bulgarian (BARD), Estonian (Tiritamm), Finnish (SETS), Hungarian (Kossuth), Japanese (Ushio), Latvian (Zvaigzne), Macedonian (Toper), Mongolian (Bolor Sudar), Norwegian (Schibsted), Persian (Parian), Portuguese in Europe (Bertrand), Serbian (Orfelin), Slovak (Albatros), Slovenian (Sanje), Thai (Amarin).

Miss Peregrine's Home for Peculiar Children

ISBN 978-1-59474-476-1
\$18.99 USD
5 1/4 x 8 1/4, 352 pages,
2c hardcover with jacket

Hollow City

ISBN 978-1-59474-612-3
\$18.99 USD
5 1/4 x 8 1/4, 400 pages,
2c hardcover with jacket

Library of Souls

ISBN 978-1-59474-758-8
\$18.99 USD
5 1/4 x 8 1/4, 464 pages,
2c hardcover with jacket

Miss Peregrine's Home for Peculiar Children Movie Tie-In Edition

ISBN 978-1-59474-902-5
\$11.99 USD
5 1/4 x 8 1/4, 392 pages,
1c paperback



RANSOM RIGGS is the #1 *New York Times* best-selling author of the *Miss Peregrine's Peculiar Children* novels. Riggs was born on a farm in Maryland and grew up in southern Florida. He studied literature at Kenyon College and film at the University of Southern California. He lives in Los Angeles with his wife, the best-selling author Tahereh Mafi, and their family.

YA Romance from Ashley Poston: The Once Upon A Con Series

Your favorite fairy tales take to the page as geeky, funny, and adorably romantic contemporary YA novels. A handsome sci-fi prince falls for a passionate fangirl. Hollywood's geeky leading lady swaps places with an ordinary con-going girl who could be her twin. Hijinks, hilarity, and sweet love stories ensue. Perfect for contemporary YA fans, geeks, cosplayers, and any readers who believe in the magic of fandom.

OVER
150,000
SOLD!

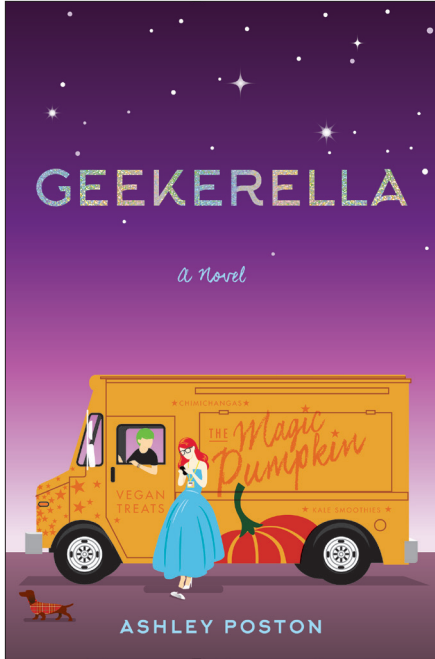

Cinderella goes to the con in this fandom-fueled twist on the classic fairy tale romance.



The Prince and the Pauper gets a *Geekerella*-style makeover in this witty and heartfelt novel.



A tale as old as time is made new in Ashley Poston's fresh, geeky retelling of *Beauty and the Beast*.

Active rights: French, Serbian, Spanish, Turkish

Expired: Indonesian, Korean, Polish, Portuguese in Brazil, Romanian, Russian, Vietnamese



ASHLEY POSTON is a *New York Times* and *USA Today* best-selling novelist who writes cozy and magical love stories. Her young adult novels have been nominated for the Indie Next List, the Goodreads Choice Awards, and have been featured in countless articles and recommended reading lists.

Dystopian from Anna Carey

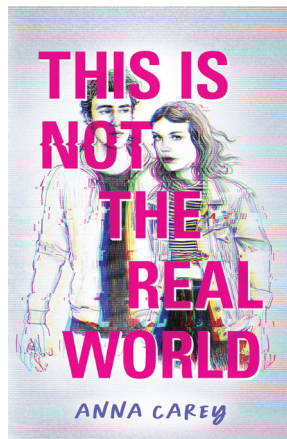

A teenage girl's reality may not be what it seems in *This Is Not the Jess Show*, a riveting young adult thriller duology blending '90s nostalgia with a speculative hook that dissects our reality TV and influencer-obsessed culture. Perfect for readers of *We Were Liars* and *One of Us Is Lying*.

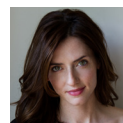

ANNA CAREY is the author of several books for teens including *This Is Not the Jess Show*, *This Is Not the Real World*, and the *Eve* trilogy. She lives in Los Angeles.

7,500 COPIES SOLD

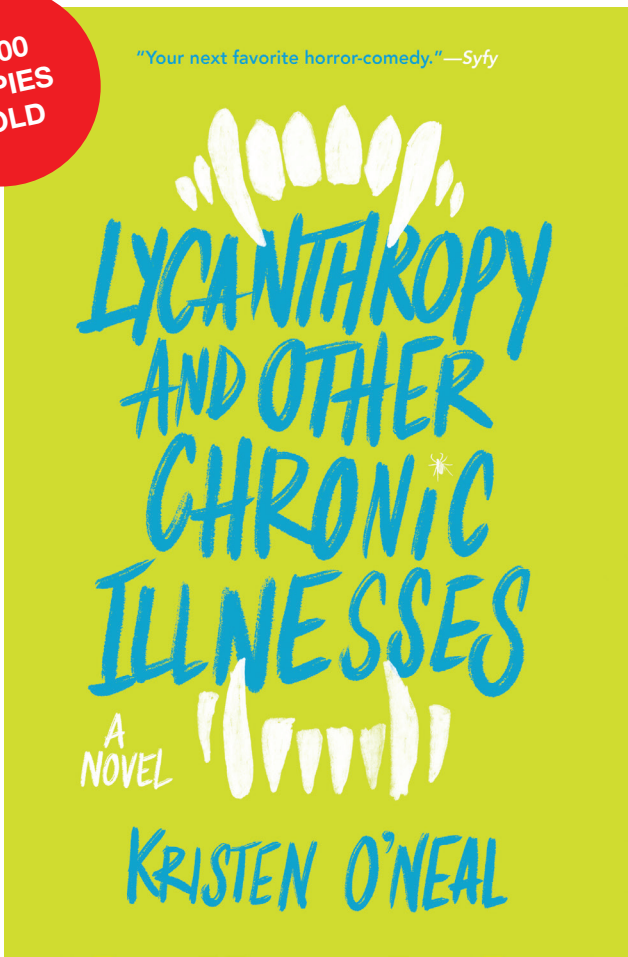

Lycanthropy and Other Chronic Illnesses

By Kristen O'Neal

Teen Wolf meets Emergency Contact in this sharply observed, hilarious, and heartwarming debut young adult novel about friendship, chronic illness, and . . . werewolves.

Priya worked hard to pursue her medical school dreams at Stanford, but a diagnosis of Lyme disease during her sophomore year sends her back to her loving but overbearing family in New Jersey—and leaves her wondering if she'll ever be able to return to the way things were. Thankfully she has her online pen pal, Brigid, and the rest of the members of “oof ouch my bones,” a virtual support group that meets on Discord to crack jokes and vent about their own chronic illnesses.

When Brigid suddenly goes offline, Priya does something out of character: she steals the family car and drives to Pennsylvania to check on Brigid. Priya isn't sure what to expect, but it isn't the horrifying creature that's shut in the basement. With Brigid nowhere to be found, Priya begins to puzzle together an impossible but obvious truth: the creature might be a werewolf—and the werewolf might be Brigid. As Brigid's unique condition worsens, their friendship will be deepened and challenged in unexpected ways, forcing them to reckon with their own ideas of what it means to be normal.



KRISTEN O'NEAL is a freelance writer who has written for sites like BuzzFeed Reader, Christianity Today, LitHub, Birth.Movies.Death, and Electric Literature. She lives on the internet. You can find her at @Kristen_ONeal on Twitter and kristenoneal on Tumblr.

Lycanthropy and Other Chronic Illnesses is her first novel.

“A funny, heartfelt book with a phenomenal premise.”

—NEW YORK TIMES

Praise for *Lycanthropy and Other Chronic Illnesses*

“At its core, the novel feels like a love letter to the internet communities that connect people; it's a reminder that friendships, both virtual and in-person, can save lives.”

—Maya Van Wagenen, *New York Times*

“Emotional, thoughtful, and a true testament to the power of friendship, *Lycanthropy and Other Chronic Illnesses* is a werewolf novel that will make you look at navigating illness, supernatural or not, in a whole new way. . . .”

—*Locus Magazine*

<p>Subject: Young Adult Fiction - Social Themes - Friendship Young Adult Fiction - Humorous - General Young Adult Fiction - Werewolves & Shifters</p>	<p>ISBN 978-1-68369-307-9 \$10.99 USD 5¼ x 8, 384 pages, 1c paperback Word count: Approx 80,000 words Age Range: 14 and up</p>	<p>Rights Sold: Audiobook (Recorded Books). All translation rights available.</p>	<p>Publication Date: April 2021</p>
--	--	--	--

Contact Info:

OUR INTERNATIONAL RIGHTS SUBAGENTS

Chinese complex and simplified, Vietnamese, and Thai

Big Apple Agency

Erica Zhou - Shanghai
erica@bigapple-china.com

Chris Lin
Big Apple Agency – Taipei
chris-lin@bigapple1.com

Dutch and Scandinavian

Sebes Bisseling Kleuver Literary Agency

Vere Bank
bank@sebes.nl

Lester Hekking
Sebes Bisseling Kleuver Literary Agency
hekking@sebes.nl

Eastern Europe excluding Hungary

Livia Stoa Literary Agency

Andrews McMeel

Oana Vasile
oana.vasile@liviastoaagency.ro

Quirk

Olivia Dobrea
olivia.dobrea@liviastoaagency.ro

French

Agence Eliane Benisti

Noémie Rollet
Noemie@elianebenisti.com

Aurélie Lefebvre
Aurelie@elianebenisti.com

German

Agence Hoffman

Dr. Uwe Neumahr
u.neumahr@agencehoffman.de

Jouli Yono
j.yono@agencehoffman.de

Greek

JLM Literary Agency

John Moukakos
jlm@jlm.gr

Hungarian

DS Budapest Kft.

Margit Gruber
margit@dsbudapest.hu

Szabolcs Török
szabolcs@dsbudapest.hu

Indonesian and Malaysian

Maxima Creative Agency

Santo Manurung
santo.manurung@maximacreativeliterary.com-
rights@maximacreativeliterary.com

Italian

The Italian Literary Agency

Elena Benaglia
elena.benaglia@italianliterary.com

Japanese

Japan UNI Agency, Inc.

Andrews McMeel

Mami Nakajima
mami.nakajima@japanuni.co.jp

Quirk

Takeshi Oyama
takeshi.oyama@japanuni.co.jp

Spanish/Portuguese

Andrews McMeel

International Editors & Yáñez Co., SL
Sandra Biel
sandra.biel@internationaleditors.com

Quirk

Ute Körner Literary Agent, S.L.U.
Iñigo Cebollada
i.cebollada@uklitag.com

Turkish

AnatoliaLit Agency

Ayşenur Tural
aysenur@anatolialit.com

For all other territories and general rights information please e-mail:

Suzanne Garrett
Director of International Sales
Andrews McMeel
suzanne.garrett@andrewsmcmeel.com

Find book and art submission instructions at:
publishing.andrewsmcmeel.com/submissions

